



ThinkSystem SD520 V4 System Configuration Guide



Machine Types: 7DFY, 7DFZ, 7DG0, and 7DG1

Note

Before using this information and the product it supports, be sure to read and understand the safety information and the safety instructions, which are available at:

https://pubs.lenovo.com/safety_documentation/

In addition, be sure that you are familiar with the terms and conditions of the Lenovo warranty for your server, which can be found at:

<http://datacentersupport.lenovo.com/warrantylookup>

First Edition (November 2024)

© Copyright Lenovo 2024.

LIMITED AND RESTRICTED RIGHTS NOTICE: If data or software is delivered pursuant to a General Services Administration (GSA) contract, use, reproduction, or disclosure is subject to restrictions set forth in Contract No. GS-35F-05925.

Contents

Contents	i	Chapter 3. Parts list	33
Safetyiii	Power cords	35
Safety inspection checklist	iv	Chapter 4. Unboxing and setup	37
Chapter 1. Introduction	1	System package contents	37
Features	1	Identify the system and access the Lenovo XClarity Controller	37
Tech Tips	3	System setup checklist	40
Security advisories	3	Chapter 5. System configuration	43
Specifications	4	Set the network connection for the Lenovo XClarity Controller	43
Chassis specifications	4	Update the firmware	44
Node technical specifications	5	Configure the firmware	48
Node mechanical specifications	9	Memory module configuration	49
Environmental specifications	9	Enable Software Guard Extensions (SGX)	49
Management options	13	RAID configuration	49
Chapter 2. Hardware components	17	Deploy the operating system	50
Front view	17	Back up the server configuration	51
Chassis front view	17	Appendix A. Getting help and technical assistance	53
Node front view	17	Before you call	53
Rear view	18	Collecting service data	54
Chassis rear view	18	Contacting Support	55
Node rear view	19	Appendix B. Documents and supports	57
Top view	21	Documents download	57
Chassis midplane	22	Support websites	57
System-board layout	24	Appendix C. Notices	59
System-board connectors	24	Trademarks	60
System-board switches	25	Important notes	60
System LEDs and diagnostics display	26	Electronic emission notices	60
Troubleshooting by system LEDs and diagnostics display	26	Taiwan Region BSMI RoHS declaration	61
Drive LEDs	26	Taiwan import and export contact information	61
Front operator panel LEDs	27		
Power supply LED	28		
Firmware and RoT security module LEDs	29		
System-board LEDs	30		
XCC system management port LEDs	31		

Safety

Before installing this product, read the Safety Information.

قبل تركيب هذا المنتج، يجب قراءة الملاحظات الأمنية

Antes de instalar este produto, leia as Informações de Segurança.

在安装本产品之前，请仔细阅读 Safety Information（安全信息）。

安裝本產品之前，請先閱讀「安全資訊」。

Prije instalacije ovog produkta obavezno pročitajte Sigurnosne Upute.

Před instalací tohoto produktu si přečtěte příručku bezpečnostních instrukcí.

Læs sikkerhedsforskrifterne, før du installerer dette produkt.

Lees voordat u dit product installeert eerst de veiligheidsvoorschriften.

Ennen kuin asennat tämän tuotteen, lue turvaohjeet kohdasta Safety Information.

Avant d'installer ce produit, lisez les consignes de sécurité.

Vor der Installation dieses Produkts die Sicherheitshinweise lesen.

Πριν εγκαταστήσετε το προϊόν αυτό, διαβάστε τις πληροφορίες ασφάλειας (safety information).

לפני שתתקינו מוצר זה, קראו את הוראות הבטיחות.

A termék telepítése előtt olvassa el a Biztonsági előírásokat!

Prima di installare questo prodotto, leggere le Informazioni sulla Sicurezza.

製品の設置の前に、安全情報をお読みください。

본 제품을 설치하기 전에 안전 정보를 읽으십시오.

Пред да се инсталира овој продукт, прочитајте информацијата за безбедност.



Les sikkerhetsinformasjonen (Safety Information) før du installerer dette produktet.

Przed zainstalowaniem tego produktu, należy zapoznać się z książką "Informacje dotyczące bezpieczeństwa" (Safety Information).

Antes de instalar este produto, leia as Informações sobre Segurança.

Перед установкой продукта прочтите инструкции по технике безопасности.

Pred inštaláciou tohto zariadenia si pečítajte Bezpečnostné predpisy.

Pred namestitvijo tega proizvoda preberite Varnostne informacije.

Antes de instalar este producto, lea la información de seguridad.

Läs säkerhetsinformationen innan du installerar den här produkten.

ཐོན་ཇུས་འདི་བདེ་སྤྱོད་མ་བྱས་གོང་། སྐྱོར་གྱི་ཡིད་གཟབ་
བྱ་འདྲ་མིན་ཡོད་པའི་འོད་སྟེར་བལྟ་དགོས།

Bu ürünü kurmadan önce güvenlik bilgilerini okuyun.

مەزكۇر مەھسۇلاتنى ئورنىتىشتىن بۇرۇن بىخەتەرلىك ئۇچۇرلىرىنى ئوقۇپ چىقىڭ.

Youq mwngz yungh canjbinj neix gaxgonq, itdingh aeu doeg aen
canjbinj soengq cungj vahgangj ancien siusik.

Safety inspection checklist

Use the information in this section to identify potentially unsafe conditions with your server. As each machine was designed and built, required safety items were installed to protect users and service technicians from injury.

Note: The product is not suitable for use at visual display workplaces according to §2 of the Workplace Regulations.

Attention: This is a Class A product. In a domestic environment, this product may cause radio interference in which case the user may be required to take adequate measures.

Note: The set-up of the server is made in the server room only.

CAUTION:

This equipment must be installed or serviced by trained personnel, as defined by the IEC 62368-1, the standard for Safety of Electronic Equipment within the Field of Audio/Video, Information Technology and Communication Technology. Lenovo assumes you are qualified in the servicing of equipment and trained in recognizing hazards energy levels in products. Access to the equipment is by the use of a tool, lock and key, or other means of security, and is controlled by the authority responsible for the location.

Important: Electrical grounding of the server is required for operator safety and correct system function. Proper grounding of the electrical outlet can be verified by a certified electrician.

Use the following checklist to verify that there are no potentially unsafe conditions:

1. Make sure that the power is off and the power cord is disconnected.
2. Check the power cord.
 - Make sure that the third-wire ground connector is in good condition. Use a meter to measure third-wire ground continuity for 0.1 ohm or less between the external ground pin and the frame ground.
 - Make sure that the power cord is the correct type.

To view the power cords that are available for the server:

a. Go to:

<http://dcsc.lenovo.com/#/>

b. Click **Preconfigured Model** or **Configure to order**.

c. Enter the machine type and model for your server to display the configurator page.

d. Click **Power → Power Cables** to see all line cords.

- Make sure that the insulation is not frayed or worn.

3. Check for any obvious non-Lenovo alterations. Use good judgment as to the safety of any non-Lenovo alterations.
4. Check inside the server for any obvious unsafe conditions, such as metal filings, contamination, water or other liquid, or signs of fire or smoke damage.
5. Check for worn, frayed, or pinched cables.
6. Make sure that the power-supply cover fasteners (screws or rivets) have not been removed or tampered with.

Chapter 1. Introduction

Lenovo ThinkSystem SD520 V4 (Types 7DFY, 7DFZ, 7DG0, and 7DG1) is a dense and economical node in a 1U rack form factor. Combining the efficiency and density of blades with the value and simplicity of rack-based servers, SD520 V4 delivers a cost-efficient scaleout platform that is thermally designed to deliver maximum performance in the smallest footprint. The system consists of a 2U D3 V2 Chassis (Types 7DGW and 7DGX) containing up to four SD520 V4 nodes, all with front access. SD520 V4 is well suited for workloads ranging from cloud, analytics to AI and high-performance computing application like Computer Aided Engineering (CAE) or Electronic Design Automation (EDA).



Figure 1. ThinkSystem SD520 V4

Features

Performance, ease of use, reliability, and expansion capabilities were key considerations in the design of your system. These design features make it possible for you to customize the system hardware to meet your needs today and provide flexible expansion capabilities for the future.

Chassis features

- **Redundant optional power capabilities**

The chassis supports up to three hot-swap CRPS power supplies, which provide redundancy.

Important:

- CRPS power supply units in the chassis must have the same vendor, wattage, and part number (or alternate part number).
- CRPS Premium (CFFv5) power supply units in the chassis must have the same wattage, and part number (or alternate part number).

- **Chassis management**

The chassis midplane with PSoC (Programmable System on Chip) allows monitor and management of nodes and power supply units in the chassis. A **chassis caretaker node** is selected by the PSoC firmware for chassis management.

For the management interface, see <https://pubs.lenovo.com/lxcc-overview/>. In XCC, certain management functions can only be performed by the caretaker node, whereas other functions can be performed by all nodes.

Function	Caretaker node ¹	Other nodes
– Supported: ✓ – Unsupported: X		
PSoC firmware update	✓	X
PSU firmware update ²	✓	X
Virtual reseal/reset for all nodes in the chassis	✓	X
View PSU inventory and events	✓	X
View chassis VPD and PSoC firmware versions	✓	✓
View PSU present status	✓	✓
View information of chassis and all nodes	✓	✓
Virtual reseal/reset for the current node itself	✓	✓
View the change history of the caretaker node	✓	✓
View the history of node installation/removal	✓	✓
View or participate in the caretaker node selection	✓	✓

Node features

Your node implements the following features and technologies:

- **Features on Demand**

If a Features on Demand feature is integrated in the system or in an optional device that is installed in the system, you can purchase an activation key to activate the feature. For information about Features on Demand, see:

<https://fod.lenovo.com/lkms>

- **Lenovo XClarity Controller (XCC)**

The Lenovo XClarity Controller is the common management controller for Lenovo ThinkSystem server hardware. The Lenovo XClarity Controller consolidates multiple management functions in a single chip on the server system board. Some of the features that are unique to the Lenovo XClarity Controller are enhanced performance, higher-resolution remote video, and expanded security options.

The system supports Lenovo XClarity Controller 3 (XCC3). For additional information about Lenovo XClarity Controller 3 (XCC3), refer to <https://pubs.lenovo.com/lxcc-overview/>.

- **UEFI-compliant server firmware**

Lenovo ThinkSystem firmware is Unified Extensible Firmware Interface (UEFI) compliant. UEFI replaces BIOS and defines a standard interface between the operating system, platform firmware, and external devices.

1. By default, the **caretaker node** is automatically selected by the PSoC firmware on the chassis midplane. To change the chassis caretaker preference, see https://pubs.lenovo.com/xcc3/NN1ia_c_d3_chassis.
2. Only the caretaker node can perform PSU firmware update.

Lenovo ThinkSystem servers are capable of booting UEFI-compliant operating systems, BIOS-based operating systems, and BIOS-based adapters as well as UEFI-compliant adapters.

Note: The system does not support Disk Operating System (DOS).

- **Active Memory**

The Active Memory feature improves the reliability of memory through memory mirroring. Memory mirroring mode replicates and stores data on two pairs of DIMMs within two channels simultaneously. If a failure occurs, the memory controller switches from the primary pair of memory DIMMs to the backup pair of DIMMs.

- **Large system-memory capacity**

The system supports TruDDR5 DIMMs operating at up to 6400 MHz. For more information about the specific types and maximum amount of memory, see “[Node technical specifications](#)” on page 5.

- **Large data-storage capacity**

With the hot-swap feature, you can add, remove, or replace hard disk drives without turning off the server.

Storage capacity is different depending on server model. See “[Node technical specifications](#)” on page 5 for more information.

- **Mobile access to Lenovo Service Information website**

The node provides a QR code on the system service label, which is on the node top cover, that you can scan using a QR code reader and scanner with a mobile device to get quick access to the Lenovo Service Information website. The Lenovo Service Information website provides additional information for parts installation, replacement videos, and error codes for system support.

- **Active Energy Manager**

Lenovo XClarity Energy Manager is a power and temperature management solution for data centers. You can monitor and manage the power consumption and temperature of Converged, NeXtScale, System x, and ThinkServer solutions, and improve energy efficiency using Lenovo XClarity Energy Manager.

- **ThinkSystem RAID support**

The ThinkSystem RAID provides software RAID (0, 1, 5, and 10) and hardware RAID (0, 1, 10, 5, 50, 6, and 60 standard).

Tech Tips

Lenovo continually updates the support website with the latest tips and techniques that you can use to solve issues that your server might encounter. These Tech Tips (also called retain tips or service bulletins) provide procedures to work around issues or solve problems related to the operation of your server.

To find the Tech Tips available for your server:

1. Go to <http://datacentersupport.lenovo.com> and navigate to the support page for your server.
2. Click on **How To's** from the navigation pane.
3. Click **Article Type** → **Solution** from the drop-down menu.

Follow the on-screen instructions to choose the category for the problem that you are having.

Security advisories

Lenovo is committed to developing products and services that adhere to the highest security standards in order to protect our customers and their data. When potential vulnerabilities are reported, it is the responsibility of the Lenovo Product Security Incident Response Team (PSIRT) to investigate and provide

information to our customers so they may put mitigation plans in place as we work toward providing solutions.

The list of current advisories is available at the following site:

https://datacentersupport.lenovo.com/product_security/home

Specifications

Summary of the features and specifications of the chassis and node. Depending on the model, some features might not be available, or some specifications might not apply.

Refer to the below table for specifications categories and the content of each category.

Specification category	“Chassis specifications” on page 4	“Node technical specifications” on page 5	“Node mechanical specifications” on page 9	“Environmental specifications” on page 9
Content	<ul style="list-style-type: none"> • Technical specifications • Mechanical specifications 	<ul style="list-style-type: none"> • “Processor” on page 6 • “Memory” on page 6 • “M.2 Drive” on page 6 • “Storage expansion” on page 7 • “Expansion slots” on page 7 • “Integrated functions” on page 7 • “Network” on page 7 • “RAID adapter” on page 8 • “Host bus adapter” on page 8 • “System fan” on page 8 • “Minimal configuration for debugging” on page 8 • “Operating systems” on page 9 	<ul style="list-style-type: none"> • Dimension • Weight 	<ul style="list-style-type: none"> • “Acoustical noise emissions” on page 9 • “Ambient temperature management” on page 10 • “Environment” on page 12

Chassis specifications

Summary of the specifications of the chassis.

Technical specifications

Table 1. Chassis technical specifications

Specification	Description
Electrical input	<p>The system supports up to three hot-swap power supplies:</p> <ul style="list-style-type: none">• CRPS 1300-watt Titanium v1.1, input power 200-240V• CRPS 2700-watt Platinum v1.3, input power 200-240V• CRPS 2700-watt Platinum v1.4, input power 200-240V• CRPS Premium (CFFv5) 2000-watt Titanium, input power 200-240V• CRPS Premium (CFFv5) 2700-watt Titanium, input power 200-240V <p>Supported power supply configurations:</p> <ul style="list-style-type: none">• 3 PSUs: 2+1 (optional redundancy)• 2 PSUs: 1+1 (optional redundancy)• 1 PSU: 1+0 (only supported on CRPS Premium (CFFv5) 2700-watt Titanium) <p>Notes:</p> <ul style="list-style-type: none">• CRPS Premium (CFFv5) PSUs support over-subscription.• The actual power efficiency depends on system configuration. <p>Important:</p> <ul style="list-style-type: none">• CRPS power supply units in the chassis must have the same vendor, wattage, and part number (or alternate part number).• CRPS Premium (CFFv5) power supply units in the chassis must have the same wattage, and part number (or alternate part number).

Mechanical specifications

Important: For safety, make sure that there is no node or power supply unit installed in the chassis when removing or installing the chassis from or to the rack.

Table 2. Chassis mechanical specifications

Specification	Description
Dimension	<p>2U rack-mounted chassis (2U4N)</p> <ul style="list-style-type: none">• Height: 87 mm (3.43 inches)• Depth: 898 mm (35.36 inches)• Width: 448 mm (17.64 inches)• Weight:<ul style="list-style-type: none">– Empty chassis (with chassis midplane and PSU cage): 11.83 kg (26.08 lbs)– Maximum (with four 1U nodes and three CRPS power supplies installed): approximately 42.37 kg (93.41 lbs)

Note: For the supported nodes for the chassis, see .

Node technical specifications

Summary of the technical specifications of the node. Depending on the model, some features might not be available, or some specifications might not apply.

Processor

Processor
<p>Supports multi-core Intel Xeon processors, with integrated memory controller and Intel Mesh UPI (Ultra Path Interconnect) topology.</p> <ul style="list-style-type: none">• One Intel Xeon 6 series scalable processor with the new LGA 4710 socket• Scalable up to 144 cores• Up to four UPI links at up to 24 GT/s• Thermal Design Power (TDP) up to 350 watts <p>For a list of supported processors, see: https://serverproven.lenovo.com.</p>

Memory

Memory
<p>See “Memory module installation rules and order” in the <i>User Guide</i> or <i>Hardware Maintenance Guide</i> for detailed information about memory configuration and setup.</p> <ul style="list-style-type: none">• Slots: 8 dual inline memory module (DIMM) connectors that support up to eight TruDDR5 6400 MHz RDIMMs• The processor has 8 memory channels, with 1 DIMM per channel• Memory module types:<ul style="list-style-type: none">– TruDDR5 6400MHz (2Rx4) RDIMM: 64 GB (2Rx4)• Speed:<ul style="list-style-type: none">– 6400 MT/s for 1 DIMM per channel– Operating speed depends on processor model and UEFI settings• Maximum memory: 512 GB <p>For a list of supported memory modules, see: https://serverproven.lenovo.com.</p>

M.2 Drive

M.2 Drive
<p>Up to two NVMe M.2 drives on the system board.</p> <ul style="list-style-type: none">• The following form factors are supported:<ul style="list-style-type: none">– 80 mm (2280)– 110 mm (22110) <p>Up to two M.2 drives on M.2 boot adapter.</p> <ul style="list-style-type: none">• The following form factors are supported:<ul style="list-style-type: none">– SATA M.2 drive:<ul style="list-style-type: none">– 42 mm (2242)– 60 mm (2260)– 80 mm (2280)– NVMe M.2 drive:<ul style="list-style-type: none">– 80 mm (2280) <p>For a list of supported M.2 drives, see: https://serverproven.lenovo.com.</p>

Storage expansion

Storage expansion
<ul style="list-style-type: none">• 2.5-inch drive configuration:<ul style="list-style-type: none">– Up to six hot-swap 2.5-inch SAS/SATA/NVMe drives <p>For a list of supported drives, see: https://serverproven.lenovo.com.</p>

Expansion slots

Expansion slots
<ul style="list-style-type: none">• PCIe riser<ul style="list-style-type: none">– One PCIe riser on the rear of the node: PCI Express 5.0 x16, HH/HL (single width)– The PCIe slot can support one PCIe adapter up to 75 watts• OCP module<ul style="list-style-type: none">– One OCP module slot

Integrated functions and I/O connectors

Integrated functions
<ul style="list-style-type: none">• Lenovo XClarity Controller (XCC), which provides service processor control and monitoring functions, video controller, and remote keyboard, video, mouse, and remote drive capabilities.• One XCC system management port (10/100/1000 Mbps RJ-45) to connect to a systems-management network. This RJ-45 connector is dedicated to the Lenovo XClarity Controller functions.• Rear connectors:<ul style="list-style-type: none">– A group of two or four Ethernet connectors on OCP Ethernet adapter– One Mini DisplayPort connector– One XCC system management port (10/100/1000 Mbps RJ-45)– One USB 3.2 Gen 1 connector– One USB 2.0 connector with Lenovo XClarity Controller (XCC) system management <p>Note: The maximum video resolution is 1920 x 1200 at 60 Hz.</p>

Network

Network
Two or four connectors on the OCP 3.0 module

RAID adapter

RAID adapter
<p>Software RAID</p> <ul style="list-style-type: none">• Intel VROC RAID1 Only: supports RAID 1 (requires activation key)• Intel VROC Standard: supports RAID 0, 1, and 10 (requires activation key)• Intel VROC Premium: supports RAID 0, 1, 5, and 10 (requires activation key) <p>Hardware RAID</p> <ul style="list-style-type: none">• ThinkSystem M.2 RAID B545i-2i SATA/NVMe Enablement Kit (RAID 0 and 1)• ThinkSystem RAID 545-8i PCIe Gen4 12Gb Adapter (RAID 0, 1, 10)• ThinkSystem RAID 940-8i 4GB Flash PCIe Gen4 12Gb Adapter (RAID 0, 1, 10, 5, 50, 6, and 60 standard) <p>For more information about the RAID/HBA adapters, see Lenovo ThinkSystem RAID Adapter and HBA Reference.</p>

Host bus adapter

Host bus adapter
<ul style="list-style-type: none">• ThinkSystem 440-16e SAS/SATA PCIe Gen4 12Gb HBA• ThinkSystem 440-16i SAS/SATA PCIe Gen4 12Gb HBA <p>For more information about the RAID/HBA adapters, see Lenovo ThinkSystem RAID Adapter and HBA Reference.</p>

System fan

System fan
Air-cooled configuration: Four high performance or ultra 4056 fans (40 x 40 x 56 mm)

Minimal configuration for debugging

Minimal configuration for debugging
<ul style="list-style-type: none">• The following minimal configuration is required for the node to start:<ul style="list-style-type: none">– One processor– One memory module in DIMM slot 5– One power supply in PSU slot 1– One boot drive, M.2 or 2.5-inch drive, and RAID adapter if configured (If OS is needed by debugging)– Four system fans

Operating systems

Operating systems
Supported and certified operating systems: <ul style="list-style-type: none">• Microsoft Windows Server• VMware ESXi• Red Hat Enterprise Linux• SUSE Linux Enterprise Server
References: <ul style="list-style-type: none">• Complete list of available operating systems: https://lenovopress.lenovo.com/osig.• OS deployment instructions, see “Deploy the operating system” on page 50.

Node mechanical specifications

Summary of the mechanical specifications of the node. Depending on the model, some features might not be available, or some specifications might not apply.

Dimension
<ul style="list-style-type: none">• Height: 40.55 mm (1.60 inches)• Width: 221.4 mm (8.72 inches)• Depth: 898 mm (35.36 inches)

Weight
Maximum: <ul style="list-style-type: none">• 8.32 kg (18.34 lbs)

Environmental specifications

Summary of the environmental specifications of server. Depending on the model, some features might not be available, or some specifications might not apply.

Acoustical noise emissions

Acoustical noise emissions			
Acoustic Performance @ 25°C Ambient		Typical	Max
Declared mean A-weighted sound power level, LWA,m(B) Statistical adder for verification, Kv (B) = 0.4	Idle	6.9	7.3
	Operating 1	6.9	7.4
	Operating 2	7.0	8.6

Acoustical noise emissions			
Declared mean A-weighted emission sound pressure level, LpA,m(dB)	Idle	55.9	60.2
	Operating 1	55.9	61.6
	Operating 2	56.6	73.4
Notes: <ul style="list-style-type: none"> • These sound levels were measured in controlled acoustical environments according to procedures specified by ISO7779 and are reported in accordance with ISO 9296. • Idle mode is the steady state in which the server is powered on but not operating any intended function. Operating mode 1 is 50% of CPU TDP. Operating Mode 2 is 100% of CPU TDP. • The declared acoustic sound levels are based on the below-specified configurations with four nodes installed in the chassis, which may change depending on configuration/conditions. <ul style="list-style-type: none"> – Typical: four 205-watt processors, thirty-two 64GB 6400 RDIMMs, four U.2 NVMe SSDs, four 10GB PCIe adapters, and two 2000-watt PSUs – Maximum: four 350-watt processors, thirty-two 64GB 6400 RDIMMs, twenty-four U.2 NVMe SSDs, four 1GB OCP modules, four GPU adapters, and three 2700-watt PSUs • Government regulations (such as those prescribed by OSHA or European Community Directives) may govern noise level exposure in the workplace and may apply to you and your server installation. The actual sound pressure levels in your installation depend upon a variety of factors, including the number of racks in the installation; the size, materials, and configuration of the room; the noise levels from other equipment; the room ambient temperature, and employee's location in relation to the equipment. Further, compliance with such government regulations depends on a variety of additional factors, including the duration of employees' exposure and whether employees wear hearing protection. Lenovo recommends that you consult with qualified experts in this field to determine whether you are in compliance with the applicable regulations. 			

Ambient temperature management

Ambient temperature management				
Adjust ambient temperature when specific components are installed.				
Notes:				
<ul style="list-style-type: none"> • To avoid throttling, make sure to adopt passive Direct Attach cables when network adapters with 100GbE or higher speed are installed. • If PCIe adapter with up to 2 ports is installed, the configuration only supports OCP module with up to 4 ports. • If PCIe adapter with up to 4 ports is installed, the configuration only supports OCP module with up to 2 ports. 				
Keep the ambient temperature to 35°C or lower with the following system configuration:				
Processor	Heat sink and Fan	Storage configuration	Slot capability	Memory capability
205W to 250W	<ul style="list-style-type: none"> • Performance heat sink • Ultra fans 	<ul style="list-style-type: none"> • One front IO board (no 2.5-inch drives) • Two M.2 boot drives 	<ul style="list-style-type: none"> • One PCIe or GPU adapter • One OCP module 	64GB (6400MHz)
200W	<ul style="list-style-type: none"> • Standard heat sink • High performance or ultra fans 			
Keep the ambient temperature to 30°C or lower with the following system configuration:				
Processor	Heat sink and Fan	Storage configuration	Slot capability	Memory capability

Ambient temperature management				
205W to 250W	<ul style="list-style-type: none"> • Performance heat sink • Ultra fans 	<ul style="list-style-type: none"> • Six 2.5-inch drives • Two M.2 boot drives 	<ul style="list-style-type: none"> • One PCIe or GPU adapter • One OCP module 	64GB (6400MHz)
205W to 250W	<ul style="list-style-type: none"> • Performance heat sink • High performance or ultra fans 	<ul style="list-style-type: none"> • Two 2.5-inch drives • Two M.2 boot drives 	<ul style="list-style-type: none"> • One PCIe or GPU adapter • One OCP module 	64GB (6400MHz)
200W	<ul style="list-style-type: none"> • Standard heat sink • High performance or ultra fans 			
205W to 250W	<ul style="list-style-type: none"> • Performance heat sink • High performance fans 	<ul style="list-style-type: none"> • One front IO board (no 2.5-inch drives) • Two M.2 boot drives 	<ul style="list-style-type: none"> • One PCIe or GPU adapter • One OCP module 	64GB (6400MHz)
270W to 350W	<ul style="list-style-type: none"> • Performance heat sink • Ultra fans 			
Keep the ambient temperature to 25°C or lower with the following system configuration:				
Processor	Heat sink and Fan	Storage configuration	Slot capability	Memory capability
270W to 350W	<ul style="list-style-type: none"> • Performance heat sink • Ultra fans 	<ul style="list-style-type: none"> • Six 2.5-inch drives • Two M.2 boot drives 	<ul style="list-style-type: none"> • One PCIe or GPU adapter • One OCP module 	64GB (6400MHz)
205W to 250W	<ul style="list-style-type: none"> • Performance heat sink • High performance or ultra fans 			
200W	<ul style="list-style-type: none"> • Standard heat sink • High performance or ultra fans 			
270W to 350W	<ul style="list-style-type: none"> • Performance heat sink • High performance or ultra fans 	<ul style="list-style-type: none"> • Two 2.5-inch drives • Two M.2 boot drives 	<ul style="list-style-type: none"> • One PCIe or GPU adapter • One OCP module 	64GB (6400MHz)
270W to 350W	<ul style="list-style-type: none"> • Performance heat sink • High performance fans 	<ul style="list-style-type: none"> • One front IO board (no 2.5-inch drives) • Two M.2 boot drives 	<ul style="list-style-type: none"> • One PCIe or GPU adapter • One OCP module 	64GB (6400MHz)

Environment

Environment
<p>ThinkSystem SD520 V4 complies with ASHRAE Class A2 specifications. System performance may be impacted when operating temperature is outside AHSRAE A2 specification.</p> <p>Depending on the hardware configuration, SD520 V4 also complies with ASHRAE Class H1 specification. System performance may be impacted when operating temperature is outside ASHRAE H1 specification.</p> <ul style="list-style-type: none">• Air temperature:<ul style="list-style-type: none">– Operating<ul style="list-style-type: none">– ASHRAE Class A2: 10°C to 35°C (50°F to 95°F); the maximum ambient temperature decreases by 1°C for every 300 m (984 ft) increase in altitude above 900 m (2,953 ft).– ASHRAE Class H1: 5°C to 25°C (41°F to 77°F); the maximum ambient temperature decreases by 1°C for every 300 m (984 ft) increase in altitude above 900 m (2,953 ft).– Server off: 5°C to 45°C (41°F to 113°F)– Shipment/storage: -40°C to 60°C (-40°F to 140°F)• Maximum altitude: 3,050 m (10,000 ft)• Relative Humidity (non-condensing):<ul style="list-style-type: none">– Operating<ul style="list-style-type: none">– ASHRAE Class A2: 8% to 80%; maximum dew point: 21°C (70°F)– ASHRAE Class H1: 8% to 80%; maximum dew point: 17°C (62.6°F)– Shipment/storage: 8% to 90%• Particulate contamination <p>Attention: Airborne particulates and reactive gases acting alone or in combination with other environmental factors such as humidity or temperature might pose a risk to the server. For information about the limits for particulates and gases, see “Particulate contamination” on page 12.</p> <p>Note: The server is designed for standard data center environment and recommended to be placed in industrial data center.</p>

Particulate contamination

Attention: Airborne particulates (including metal flakes or particles) and reactive gases acting alone or in combination with other environmental factors such as humidity or temperature might pose a risk to the device that is described in this document.

Risks that are posed by the presence of excessive particulate levels or concentrations of harmful gases include damage that might cause the device to malfunction or cease functioning altogether. This specification sets forth limits for particulates and gases that are intended to avoid such damage. The limits must not be viewed or used as definitive limits, because numerous other factors, such as temperature or moisture content of the air, can influence the impact of particulates or environmental corrosives and gaseous contaminant transfer. In the absence of specific limits that are set forth in this document, you must implement practices that maintain particulate and gas levels that are consistent with the protection of human health and safety. If Lenovo determines that the levels of particulates or gases in your environment have caused damage to the device, Lenovo may condition provision of repair or replacement of devices or parts on implementation of appropriate remedial measures to mitigate such environmental contamination. Implementation of such remedial measures is a customer responsibility.

Table 3. Limits for particulates and gases

Contaminant	Limits
Reactive gases	<p>Severity level G1 as per ANSI/ISA 71.04-1985¹:</p> <ul style="list-style-type: none"> • The copper reactivity level shall be less than 200 Angstroms per month ($\text{\AA}/\text{month} \approx 0.0035 \mu\text{g}/\text{cm}^2\text{-hour weight gain}$).² • The silver reactivity level shall be less than 200 Angstroms per month ($\text{\AA}/\text{month} \approx 0.0035 \mu\text{g}/\text{cm}^2\text{-hour weight gain}$).³ • The reactive monitoring of gaseous corrosivity must be conducted approximately 5 cm (2 in.) in front of the rack on the air inlet side at one-quarter and three-quarter frame height off the floor or where the air velocity is much higher.
Airborne particulates	<p>Data centers must meet the cleanliness level of ISO 14644-1 class 8.</p> <p>For data centers without airside economizer, the ISO 14644-1 class 8 cleanliness might be met by choosing one of the following filtration methods:</p> <ul style="list-style-type: none"> • The room air might be continuously filtered with MERV 8 filters. • Air entering a data center might be filtered with MERV 11 or preferably MERV 13 filters. <p>For data centers with airside economizers, the choice of filters to achieve ISO class 8 cleanliness depends on the specific conditions present at that data center.</p> <ul style="list-style-type: none"> • The deliquescent relative humidity of the particulate contamination should be more than 60% RH.⁴ • Data centers must be free of zinc whiskers.⁵
<p>cu</p> <p>¹ ANSI/ISA-71.04-1985. <i>Environmental conditions for process measurement and control systems: Airborne contaminants</i>. Instrument Society of America, Research Triangle Park, North Carolina, U.S.A.</p> <p>² The derivation of the equivalence between the rate of copper corrosion growth in the thickness of the corrosion product in $\text{\AA}/\text{month}$ and the rate of weight gain assumes that Cu_2S and Cu_2O grow in equal proportions.</p> <p>³ The derivation of the equivalence between the rate of silver corrosion growth in the thickness of the corrosion product in $\text{\AA}/\text{month}$ and the rate of weight gain assumes that Ag_2S is the only corrosion product.</p> <p>⁴ The deliquescent relative humidity of particulate contamination is the relative humidity at which the dust absorbs enough water to become wet and promote ionic conduction.</p> <p>⁵ Surface debris is randomly collected from 10 areas of the data center on a 1.5 cm diameter disk of sticky electrically conductive tape on a metal stub. If examination of the sticky tape in a scanning electron microscope reveals no zinc whiskers, the data center is considered free of zinc whiskers.</p>	

Management options

The XClarity portfolio and other system management options described in this section are available to help you manage the servers more conveniently and efficiently.

Overview

Options	Description
Lenovo XClarity Controller	<p>Baseboard management controller (BMC)</p> <p>Consolidates the service processor functionality, Super I/O, video controller, and remote presence capabilities into a single chip on the server system board (system board assembly).</p> <p>Interface</p> <ul style="list-style-type: none"> • CLI application • Web GUI interface • Mobile application • Redfish API <p>Usage and downloads</p> <p>https://pubs.lenovo.com/lxcc-overview/</p>
Lenovo XCC Logger Utility	<p>Application that reports the XCC events to local OS system log.</p> <p>Interface</p> <ul style="list-style-type: none"> • CLI application <p>Usage and downloads</p> <ul style="list-style-type: none"> • https://pubs.lenovo.com/lxcc-logger-linux/ • https://pubs.lenovo.com/lxcc-logger-windows/
Lenovo XClarity Administrator	<p>Centralized interface for multi-server management.</p> <p>Interface</p> <ul style="list-style-type: none"> • Web GUI interface • Mobile application • REST API <p>Usage and downloads</p> <p>https://pubs.lenovo.com/lxca/</p>
Lenovo XClarity Essentials toolset	<p>Portable and light toolset for server configuration, data collection, and firmware updates. Suitable both for single-server or multi-server management contexts.</p> <p>Interface</p> <ul style="list-style-type: none"> • OneCLI: CLI application • Bootable Media Creator: CLI application, GUI application • UpdateXpress: GUI application <p>Usage and downloads</p> <p>https://pubs.lenovo.com/lxce-overview/</p>

Options	Description
Lenovo XClarity Provisioning Manager	<p>UEFI-based embedded GUI tool on a single server that can simplify management tasks.</p> <p>Interface</p> <ul style="list-style-type: none"> • Web interface (BMC remote access) • GUI application <p>Usage and downloads</p> <p>https://pubs.lenovo.com/lxpm-overview/</p> <p>Important: Lenovo XClarity Provisioning Manager (LXPM) supported version varies by product. All versions of Lenovo XClarity Provisioning Manager are referred to as Lenovo XClarity Provisioning Manager and LXPM in this document, unless specified otherwise. To see the LXPM version supported by your server, go to https://pubs.lenovo.com/lxpm-overview/.</p>
Lenovo XClarity Integrator	<p>Series of applications that integrate the management and monitoring functionalities of the Lenovo physical servers with the software used in a certain deployment infrastructure, such as VMware vCenter, Microsoft Admin Center, or Microsoft System Center while delivering additional workload resiliency.</p> <p>Interface</p> <ul style="list-style-type: none"> • GUI application <p>Usage and downloads</p> <p>https://pubs.lenovo.com/lxci-overview/</p>
Lenovo XClarity Energy Manager	<p>Application that can manage and monitor server power and temperature.</p> <p>Interface</p> <ul style="list-style-type: none"> • Web GUI Interface <p>Usage and downloads</p> <p>https://datacentersupport.lenovo.com/solutions/Invo-lxem</p>
Lenovo Capacity Planner	<p>Application that supports power consumption planning for a server or rack.</p> <p>Interface</p> <ul style="list-style-type: none"> • Web GUI Interface <p>Usage and downloads</p> <p>https://datacentersupport.lenovo.com/solutions/Invo-lcp</p>

Functions

Options		Functions							
		Multi-system mgmt	OS deployment	System configuration	Firmware updates ¹	Event/alert monitoring	Inventory/logs	Power mgmt	Power planning
Lenovo XClarity Controller				√	√ ²	√	√ ⁴		
Lenovo XCC Logger Utility						√			
Lenovo XClarity Administrator		√	√	√	√ ²	√	√ ⁴		
Lenovo XClarity Essentials toolset	OneCLI	√		√	√ ²	√	√		
	Bootable Media Creator			√	√ ²		√ ⁴		
	UpdateXpress			√	√ ²				
Lenovo XClarity Provisioning Manager			√	√	√ ³		√ ⁵		
Lenovo XClarity Integrator		√		√	√	√	√	√ ⁶	
Lenovo XClarity Energy Manager		√				√		√	
Lenovo Capacity Planner									√ ⁷

Notes:

1. Most options can be updated through the Lenovo tools. Some options, such as GPU firmware or Omni-Path firmware require the use of supplier tools.
2. The server UEFI settings for option ROM must be set to **Auto** or **UEFI** to update firmware using Lenovo XClarity Administrator, Lenovo XClarity Essentials, or Lenovo XClarity Controller.
3. Firmware updates are limited to Lenovo XClarity Provisioning Manager, Lenovo XClarity Controller, and UEFI updates only. Firmware updates for optional devices, such as adapters, are not supported.
4. The server UEFI settings for option ROM must be set to **Auto** or **UEFI** for detailed adapter card information, such as model name and firmware levels, to be displayed in Lenovo XClarity Administrator, Lenovo XClarity Controller, or Lenovo XClarity Essentials.
5. Limited inventory.
6. Power management function is supported only by Lenovo XClarity Integrator for VMware vCenter.
7. It is highly recommended that you check the power summary data for your server using Lenovo Capacity Planner before purchasing any new parts.

Chapter 2. Hardware components

This section contains information about each of the components in the chassis and node.

Front view

The following sections show the controls, LEDs, and connectors on the front of the chassis and node.

Chassis front view

This section contains information on the front of the chassis installed with nodes.

The chassis can contain up to four 1U nodes.

Important:

- For proper cooling, each node tray must be installed with either a node or node tray fillers before the nodes in the chassis are powered on.
- The installation of nodes must follow the sequence of the tray numbering.

Four 1U nodes

For four 1U nodes: the two nodes in the right trays (**2** and **4**) must be installed upside down.

The following illustration shows the front view of the chassis and respective node trays in the chassis.

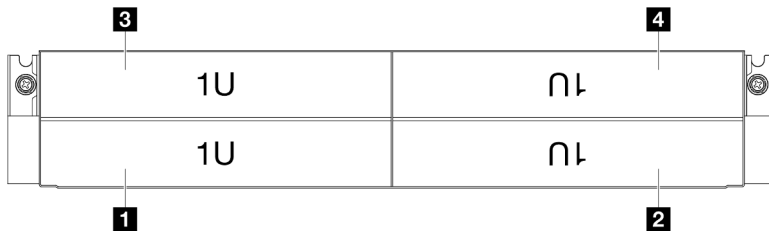

Figure 2. Chassis front view with four 1U nodes

3 Node tray 3	4 Node tray 4
1 Node tray 1	2 Node tray 2

Node front view

This section contains information on the controls and connectors on the front of the ThinkSystem SD520 V4 node.

Configuration with six 2.5-inch drives

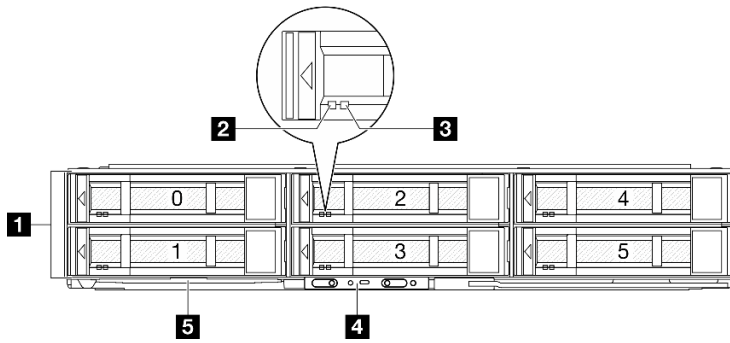

Table 4. Configuration with six 2.5-inch drives

1 “2.5-inch drive bays” on page 18	2 “Drive activity LED” on page 18
3 “Drive status LED” on page 18	4 “Front operator panel buttons and LEDs” on page 18
5 “Pull-out information tab” on page 18	

1 2.5-inch drive bays

Install 2.5-inch drives or drive fillers to these bays, see “Hot-swap drive replacement” in the *ThinkSystem SD520 V4 User Guide* or *ThinkSystem SD520 V4 Hardware Maintenance Guide*.

2 Drive activity LED

For more information about the drive activity LED, see “Drive LEDs” on page 26.

3 Drive status LED

For more information about the drive status LED, see “Drive LEDs” on page 26.

4 Front operator panel buttons and LEDs

For more information about the Front operator panel buttons and LEDs, see “Front operator panel LEDs” on page 27.

5 Pull-out information tab

This tab contains below information:

- Network information such as MAC address and XCC network access label.
- Drive bay numbers.

For more information about this tab, see “Identify the system and access the Lenovo XClarity Controller” on page 37.

Rear view

The following sections show the rear of the chassis and node.

Chassis rear view

This section contains information on the rear of the chassis.

Notes:

- Depending on the specific configuration, the hardware might look slightly different from the illustrations in this section.

Important:

- For proper cooling, each node tray must be installed with either a node or node tray fillers before the nodes in the chassis are powered on.

Chassis rear view

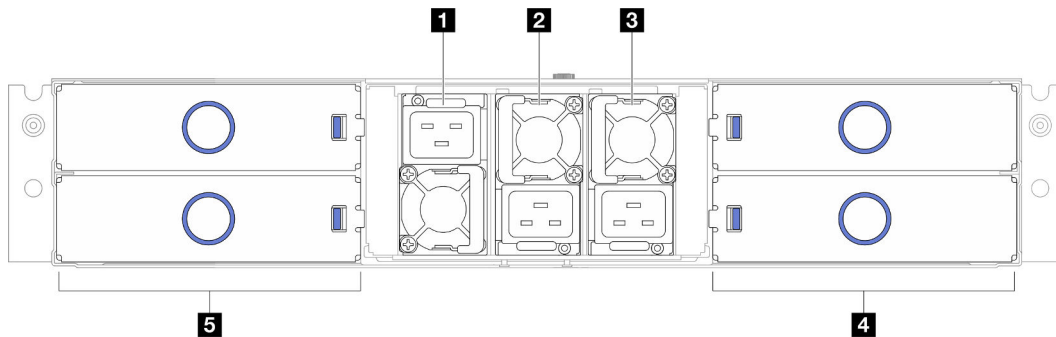

Figure 3. Chassis rear view

Table 5. Components on the rear of the chassis

1 PSU slot 1 (the PSU must be installed with the fan downward)	2 PSU slot 2 (the PSU must be installed with the fan upward)
3 PSU slot 3 (the PSU must be installed with the fan upward)	4 Node trays (the nodes must be installed right-side up)
5 Node trays (the nodes must be installed upside down)	

1 / 2 / 3 PSU slots

Install power supply units to these slots, connect them to power cords. Make sure the power cords are connected properly.

Important: When installing the power supply units, make sure to follow the instruction on the label in each slot.

- For slot 1 (**1**), the PSU must be installed with the fan downward.
- For slots 2 and 3 (**2** and **3**), the PSU must be installed with the fan upward.

Following are the power supplies supported by the system:

- CRPS 1300-watt Titanium v1.1, input power 200-240V
- CRPS 2700-watt Platinum v1.3, input power 200-240V
- CRPS 2700-watt Platinum v1.4, input power 200-240V
- CRPS Premium (CFFv5) 2000-watt Titanium, input power 200-240V
- CRPS Premium (CFFv5) 2700-watt Titanium, input power 200-240V

For more information on the power supply LED, see [“Power supply LED” on page 28](#).

Node rear view

This section contains information on the controls and connectors on the rear of the ThinkSystem SD520 V4 node.

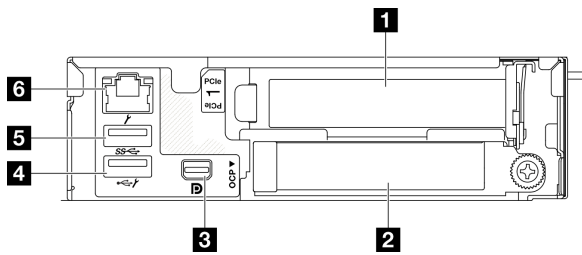

Table 6. Node rear view

1 “PCIe slot 1” on page 20	2 “OCP slot” on page 20
3 “Mini DisplayPort connector” on page 20	4 “USB 2.0 connector with Lenovo XClarity Controller (XCC) management” on page 21
5 “USB 3.2 Gen 1 (5 Gbps) connector” on page 21	6 “XCC system management port (10/100/1000 Mbps RJ-45)” on page 21

1 PCIe slot

Install PCIe adapters into these PCIe slots. See “Install a PCIe adapter” in *ThinkSystem SD520 V4 User Guide* or *ThinkSystem SD520 V4 Hardware Maintenance Guide*.

2 OCP slot

The system may support a 2-port or a 4-port OCP module for network connections. Port numbering are shown in the illustrations below.

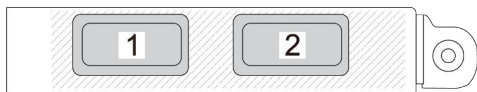

Figure 4. Port numbering — 2-port OCP module

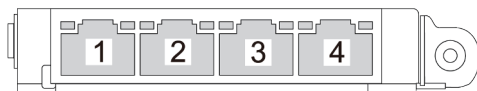

Figure 5. Port numbering — 4-port OCP 3.0 module

3 Mini DisplayPort connector

Connect a Mini DisplayPort-compatible video device, such as a monitor, to this connector.

Note: The maximum video resolution is 1920 x 1200 at 60 Hz.

4 USB 2.0 connector with Lenovo XClarity Controller (XCC) management

Note: This is the only USB port that supports USB automation update of the firmware and RoT security module.

Connection to Lenovo XClarity Controller is primarily intended for users with a mobile device running the Lenovo XClarity Controller mobile application. When a mobile device is connected to this USB port, an Ethernet over USB connection is established between the mobile application running on the device and the Lenovo XClarity Controller.

Select **Network** in **BMC Configuration** to view or modify settings.

Four types of settings are available:

- **Host only mode**

In this mode, the USB port is always solely connected to the server.

- **BMC only mode**

In this mode, the USB port is always solely connected to Lenovo XClarity Controller.

- **Shared mode: owned by BMC**

In this mode, connection to the USB port is shared by the server and Lenovo XClarity Controller, while the port is switched to Lenovo XClarity Controller.

- **Shared mode: owned by host**

In this mode, connection to the USB port is shared by the server and Lenovo XClarity Controller, while the port is switched to the server.

5 XCC system management port (10/100/1000 Mbps RJ-45)

The node has a 10/100/1000 Mbps RJ-45 connector dedicated to Lenovo XClarity Controller, which cannot be accessed directly from the production network. A dedicated management network provides additional security by physically separating the management network traffic from the production network. You can use the Setup Utility to configure the node to use a dedicated systems-management network or a shared network.

See the following for more information:

- [“Set the network connection for the Lenovo XClarity Controller” on page 43](#)
- [“XCC system management port LEDs” on page 31](#)

6 USB 3.2 Gen 1 (5 Gbps) connector

Connect a USB device, such as a mouse, keyboard, or other devices, to this connector.

Top view

This section contains information on the top view of the node.

Note: Depending on the specific configuration, the hardware might look slightly different from the illustrations in this section.

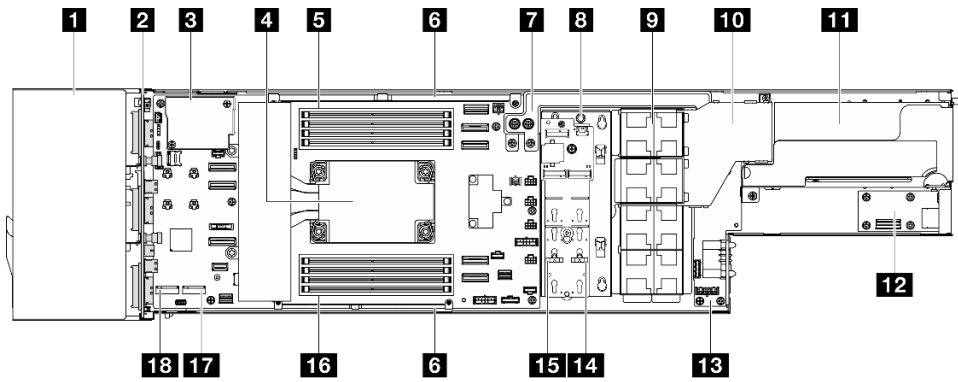

Figure 6. Top view of node

1 Drive cage	2 Drive backplane or front I/O board
3 Firmware and RoT security module	4 Processor and heat sink
5 Memory modules 5-8	6 Cable wall
7 Power bus bar	8 M.2 boot adapter or flash power module
9 Fans and fan cage	10 Air duct
11 PCIe riser assembly	12 Rear I/O module
13 Power distribution board	14 M.2 bay 1
15 M.2 bay 0	16 Memory modules 1-4
17 M.2 bay 2	18 M.2 bay 3

Chassis midplane

The following illustration shows the location and connectors of the chassis midplane.

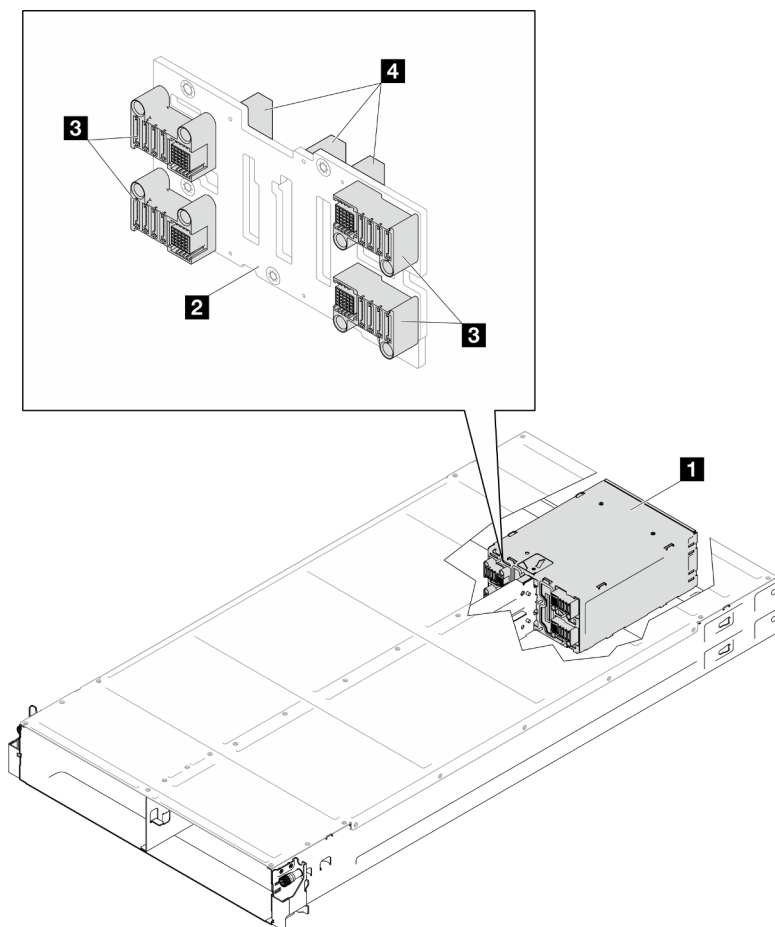

Figure 7. Chassis midplane location and connectors

1 PSU cage	3 PDB connectors
2 Chassis midplane	4 PSU connectors

1 PSU cage: For the PSU slots, see “Chassis rear view” on page 18.

2 Chassis midplane: For the replacement of the PSU cage and Chassis midplane, see “PSU cage and chassis midplane replacement” in the *User Guide* or *Hardware Maintenance Guide*.

3 PDB connectors: When a node is installed in the chassis, the power distribution board (PDB) in the node is connected to the corresponding connector on the chassis midplane.

4 PSU connectors: When a hot-swap power supply unit (PSU) is installed in the PSU cage, the PSU is connected to the corresponding connector on the chassis midplane.

Notes:

- The firmware of the chassis midplane can be updated via Lenovo XClarity Controller (XCC) and Lenovo XClarity Essentials OneCLI (LXCE OneCLI). **Only the caretaker node can perform this update.**
- By default, the **caretaker node** is automatically selected by the PSoC firmware on the chassis midplane. To change the chassis caretaker preference, see https://pubs.lenovo.com/xcc3/NN1ia_c_d3_chassis.
- Go to for more information on firmware updating tools.

System-board layout

The following sections provide information about the connectors and switches that are available on the system board.

For more information about the LEDs that are available on the system board, see [“System-board LEDs” on page 30](#).

System-board connectors

This section contains information on the internal connectors on the system board.

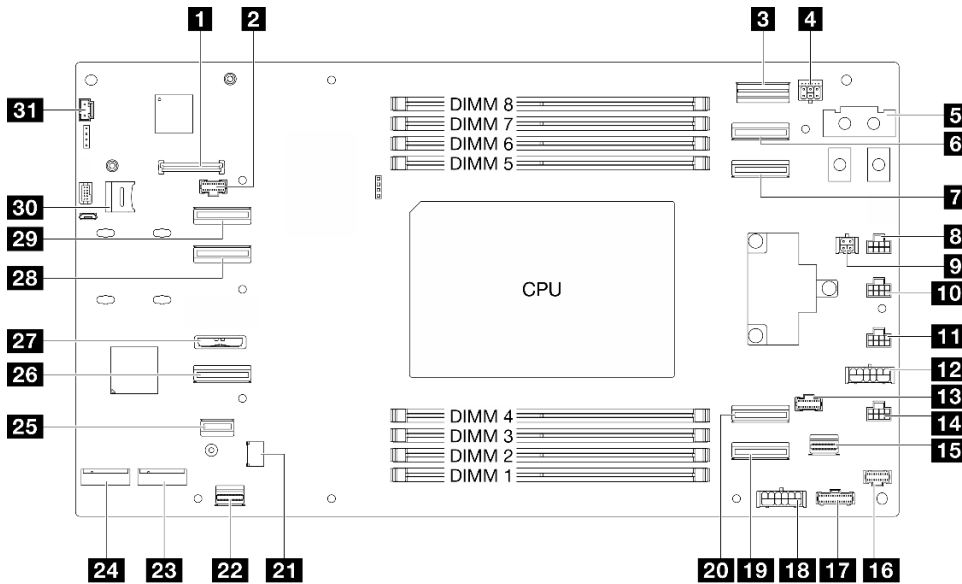

1 Firmware and RoT security module connector	2 Drive backplane sideband connector
3 OCP sideband connector	4 Drive backplane power connector
5 Power bus bar connector	6 OCP signal connector 1
7 OCP signal connector 2	8 Fan 1 connector
9 Leakage sensor connector	10 Fan 2 connector
11 Fan 3 connector	12 PCIe riser power connector
13 PCIe riser sideband connector	14 Fan 4 connector
15 Rear I/O Ethernet connector	16 M.2 boot adapter power and sideband connector
17 PDB management connector	18 PDB auxiliary power connector
19 PCIe riser connector 1	20 PCIe riser connector 2
21 TPM connector	22 Rear I/O USB DP connector
23 M.2 bay 2	24 M.2 bay 3
25 M.2 boot adapter signal connector	26 NVMe 4-5 connector
27 CMOS battery socket	28 NVMe 2-3 connector

29 NVMe 0-1 connector	30 MicroSD card socket
31 Thermal sensor connector	

System-board switches

This section contains information on the location of the switches on the server.

Important:

- Before you change any switch settings or move any jumpers, turn off the server; then, disconnect all power cords and external cables. Review the following information:
 - https://pubs.lenovo.com/safety_documentation/
 - “Installation Guidelines”, “Handling static sensitive devices”, and “Power off the server ” in *User Guide* or *Hardware Maintenance Guide*.
- Any system-board switch or jumper block that is not shown in the illustrations in this document are reserved.

Note: If there is a clear protective sticker on the top of the switch blocks, you must remove and discard it to access the switches.

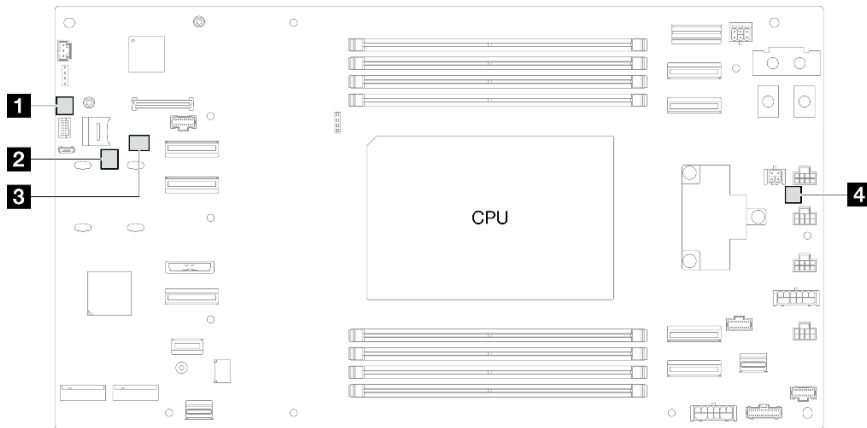

Figure 8. System-board switches

1 SW2	2 SW31C
3 SWX2	4 SW1

SW2 switch block

Table 7. SW2 switch block definition

Switch number	Switch name	Usage description	
		On	Off
1	Password clear	Forces reset UEFI password	Normal (default)
2	(Reserved)	(Reserved)	Normal (default)
3	(Reserved)	(Reserved)	Normal (default)
4	(Reserved)	(Reserved)	Normal (default)

SW31C switch block

Table 8. SW31C switch block definition

Switch number	Switch name	Usage description	
		On	Off
1	(Reserved)	(Reserved)	Normal (default)
2	(Reserved)	(Reserved)	Normal (default)
3	(Reserved)	Normal (default)	(Reserved)
4	(Reserved)	(Reserved)	Normal (default)

SWX2 switch block

Table 9. SWX2 switch block definition

Switch number	Switch name	Usage description	
		On	Off
1	(Reserved)	(Reserved)	Normal (default)
2	Low security	Enables XCC low security mode	(Reserved)
3	Force BMC reset	Force hot reset BMC chip	Normal (default)
4	XCC boot primary	Request XCC to boot from backup bank	Normal (default)

SW1 switch block

Table 10. SW1 switch block definition

Switch number	Switch name	Usage description	
		On	Off
1	Clear CMOS	Clears CMOS data	Normal (default)
2	(Reserved)	(Reserved)	Normal (default)
3	(Reserved)	(Reserved)	Normal (default)
4	(Reserved)	(Reserved)	Normal (default)

System LEDs and diagnostics display

The following section provides information on available system LEDs and diagnostics display.

For more information, refer to [“Troubleshooting by system LEDs and diagnostics display”](#) on page 26.

Troubleshooting by system LEDs and diagnostics display

See the following section for information on available system LEDs and diagnostics display.

Drive LEDs

This topic provides information on drive LEDs.

Location of 2.5-inch drive LEDs

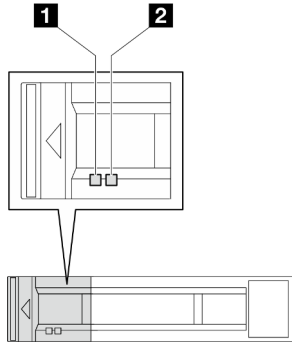

The following table describes the problems that are indicated by drive activity LED and drive status LED.

LED	Description
1 Drive activity LED (green)	Each hot-swap drive comes with an activity LED. When this LED is flashing, it indicates that the drive is in use.
2 Drive status LED (yellow)	The drive status LED indicates the following status: <ul style="list-style-type: none"> • The LED is lit: the drive has failed. • The LED is flashing slowly (once per second): the drive is being rebuilt. • The LED is flashing rapidly (three times per second): the drive is being identified.

Front operator panel LEDs

The front operator panel of the node provides controls, connectors, and LEDs.

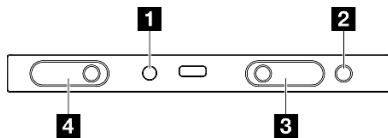

Figure 9. Front operator panel buttons and LEDs

1 (Reserved)	2 “System Error LED (yellow)” on page 27
3 “System ID button with system ID LED (blue)” on page 28	4 “Power button with power status LED (green)” on page 28

System Error LED (yellow)

The system error LED helps you to determine if there are any system errors.

Status	Color	Description	Action
On	Yellow	<p>An error has been detected on the server. Causes might include one or more of the following errors:</p> <ul style="list-style-type: none"> • The temperature of the server reached the non-critical temperature threshold. • The voltage of the server reached the non-critical voltage threshold. • A fan has been detected to be running at low speed. • The power supply has a critical error. • The power supply is not connected to the power. 	Check the Event log to determine the exact cause of the error.
Off	None	The server is off or the server is on and is working correctly.	None.

System ID button with system ID LED (blue)

Use this system ID button and the blue system ID LED to visually locate the server. Each time you press the system ID button, the state of the system ID LED changes. The LED can be changed to on, blinking, or off. You can also use the Lenovo XClarity Controller or a remote management program to change the state of the system ID LED to assist in visually locating the server among other servers.

Power button with power status LED (green)

You can press the power button to power on the server when you finish setting up the server. You also can hold the power button for several seconds to power off the server if you cannot shut down the server from the operating system. The states of the power LED are as follows:

Status	Color	Description
Off	None	No power supply is properly installed, or the LED itself has failed.
Flashing rapidly (four times per second)	Green	The server is turned off and is not ready to be turned on. The power button is disabled. This will last approximately 5 to 10 seconds.
Flashing slowly (once per second)	Green	The server is turned off and is ready to be turned on. You can press the power button to turn on the server.
Lit	Green	The server is turned on.

Power supply LED

This topic provides information about various power supply LED status and corresponding action suggestions.

- The following minimal configuration is required for the node to start:
 - One processor
 - One memory module in DIMM slot 5
 - One power supply in PSU slot 1
 - One boot drive, M.2 or 2.5-inch drive, and RAID adapter if configured (If OS is needed by debugging)
 - Four system fans

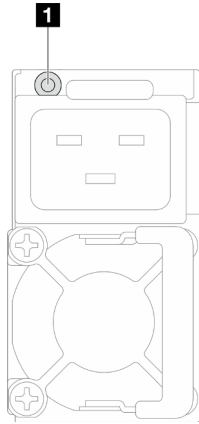

Figure 10. Power supply LED

LED	Description
1 Power supply status	<p>The power supply status LED can be in one of the following states:</p> <ul style="list-style-type: none"> • Green: The power supply is connected to the AC power source and working normally. • Off: The power supply is disconnected from the AC power source. • Slow blinking green (about one flash every second): The power supply is in PSU standby state with AC present, cold standby state, or always standby state. • Amber: The AC power cord is unplugged, AC power lost (with a second power supply in parallel still in AC power input power), or power supply has failed. To resolve the issue, replace the power supply. • Slow blinking amber (about one flash every second): Power supply warning events where the power supply continues to operate.

Firmware and RoT security module LEDs

The following illustration shows the light-emitting diodes (LEDs) on the Firmware and RoT security module.

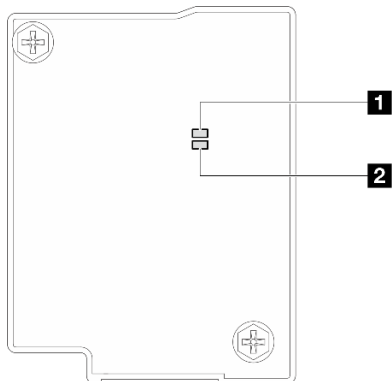

Figure 11. LEDs on the firmware and RoT security module

1 BMC LED (Green)	2 UEFI LED (Green)
--------------------------	---------------------------

Table 11. LEDs description

Scenario	BMC LED	UEFI LED	Fatal Error LED	XCC heart-beat LED ^{note}	Actions
RoT security module fatal firmware failure	Off	Off	On	N/A	Replace the firmware and RoT security module.
	Blink	N/A	On	N/A	
	Blink	N/A	On	N/A	
No system power	Off	Off	Off	Off	<p>If the AC power is on, but the system board does not have power, then:</p> <ol style="list-style-type: none"> 1. Check the power supply unit (PSU) or chassis midplane. If the PSU or chassis midplane has any error, replace it. 2. If there is no problem with the PSU or chassis midplane, replace the system board.
XCC firmware recoverable error	Blink	N/A	Off	N/A	Information only. No action is required.
XCC firmware is recovered from error	On	N/A	Off	N/A	
UEFI firmware authentication failure	N/A	Blink	Off	N/A	
UEFI firmware is recovered from authentication failure	N/A	On	Off	N/A	
System is OK	On	On	Off	On	

Note: For XCC heartbeat LED location, see [“System-board LEDs” on page 30](#).

System-board LEDs

This section contains information on the light-emitting diodes (LEDs) on the system board.

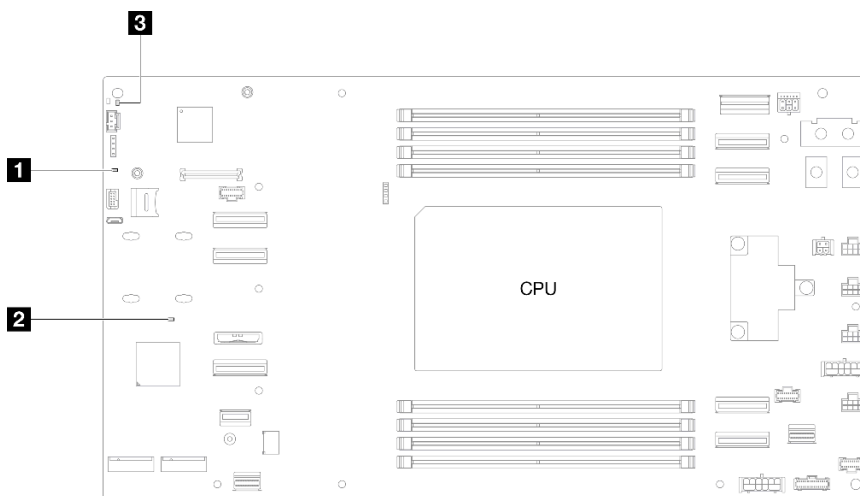

1 System power LED (yellow)	2 XCC heartbeat LED (green)
3 FPGA heartbeat LED (green)	

- **1 System power LED (yellow)**

Off: No power supply is properly installed, or the LED itself has failed.

Blinking rapidly (four times per second): The node is turned off and is not ready to be turned on. The power button is disabled. This will last approximately 5 to 10 seconds.

Blinking slowly (once per second): The node is turned off and is ready to be turned on. You can press the power button to turn on the node.

On: The node is turned on.

- **2 XCC heartbeat LED (green)**

Blinking slowly: XCC is functioning.

Blinking rapidly and constantly: XCC is initializing or malfunctioning.

On: XCC is malfunctioning.

Off: XCC is malfunctioning.

- **3 FPGA heartbeat LED (green)**

On or off: FPGA is not working.

Blinking slowly (once per second): The node is turned off and is not ready to be turned on. The power button is disabled. This will last approximately 5 to 10 seconds.

XCC system management port LEDs

This topic provides information on LEDs of XCC system management port (10/100/1000 Mbps RJ-45).

The following table describes the problems that are indicated by LEDs on XCC system management port (10/100/1000 Mbps RJ-45).

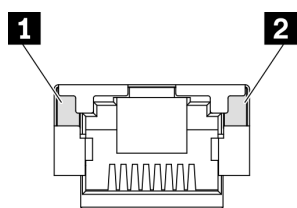

Figure 12. XCC system management port (10/100/1000 Mbps RJ-45) LEDs

LED	Description
1 XCC system management port (10/100/1000 Mbps RJ-45) link LED	Use this green LED to distinguish the network connectivity status: <ul style="list-style-type: none"> • Off: The network link is disconnected. • Green: The network link is established.
2 XCC system management port (10/100/1000 Mbps RJ-45) activity LED	Use this green LED to distinguish the network activity status: <ul style="list-style-type: none"> • Off: The server is disconnected from a LAN. • Green (blinking): The network is connected and active.

Chapter 3. Parts list

Identify each of the components that is available for your server with the parts list.

For more information about ordering parts:

1. Go to <http://datacentersupport.lenovo.com> and navigate to the support page for your node or chassis.
2. Click **Parts**.
3. Enter the serial number to view a listing of parts for your system.

It is highly recommended that you check the power summary data for your server using Lenovo Capacity Planner before purchasing any new parts.

Note: Depending on the model, your server components might look slightly different from the illustration.

The parts listed in the following tables are identified as one of the following:

- **T1:** Tier 1 customer replaceable unit (CRU). Replacement of Tier 1 CRUs is your responsibility. If Lenovo installs a Tier 1 CRU at your request with no service agreement, you will be charged for the installation.
- **T2:** Tier 2 customer replaceable unit (CRU). You may install a Tier 2 CRU yourself or request Lenovo to install it, at no additional charge, under the type of warranty service that is designated for your server.
- **F:** Field replaceable unit (FRU). FRUs must be installed only by trained service technicians.
- **C:** Consumable and Structural parts. Purchase and replacement of consumable and structural parts is your responsibility. If Lenovo acquires or installs a structural component at your request, you will be charged for the service.

Chassis components

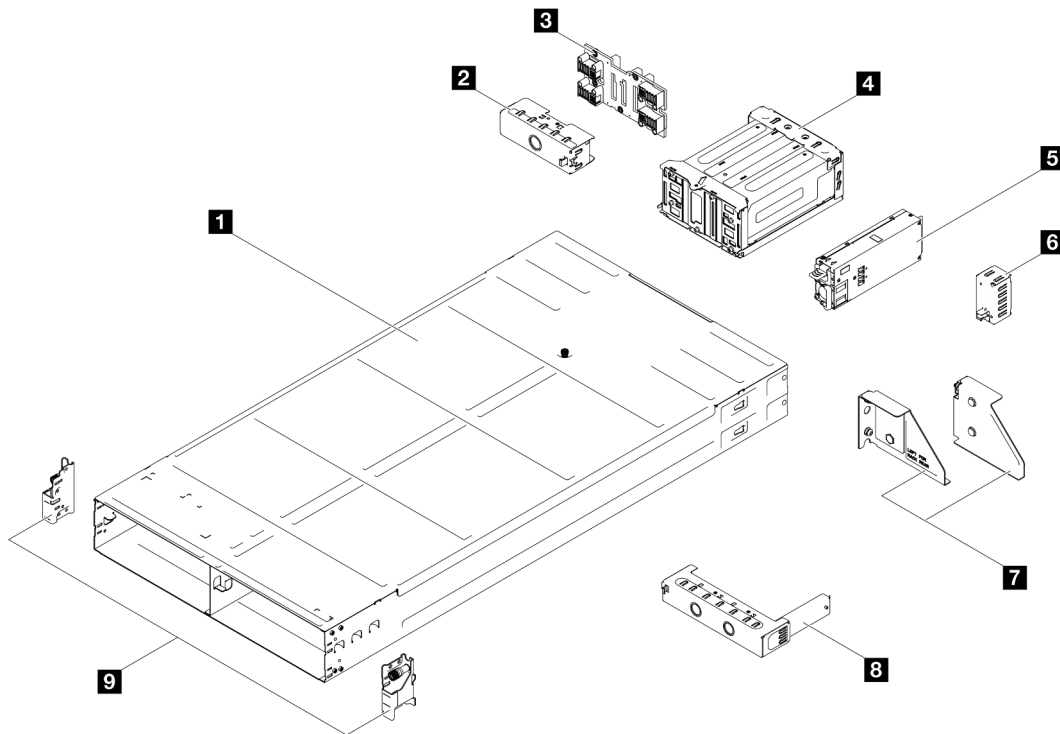

Figure 13. Chassis components

Description	Type
1 Chassis	T2
2 Node tray rear filler	T1
3 Chassis midplane	T2
4 PSU cage	T1
5 CRPS power supply unit	T2
6 PSU filler	T1
7 Chassis rear shipping brackets (left and right)	T1
8 Node tray front filler	T1
9 Chassis front EIA brackets (left and right)	T1

Node components

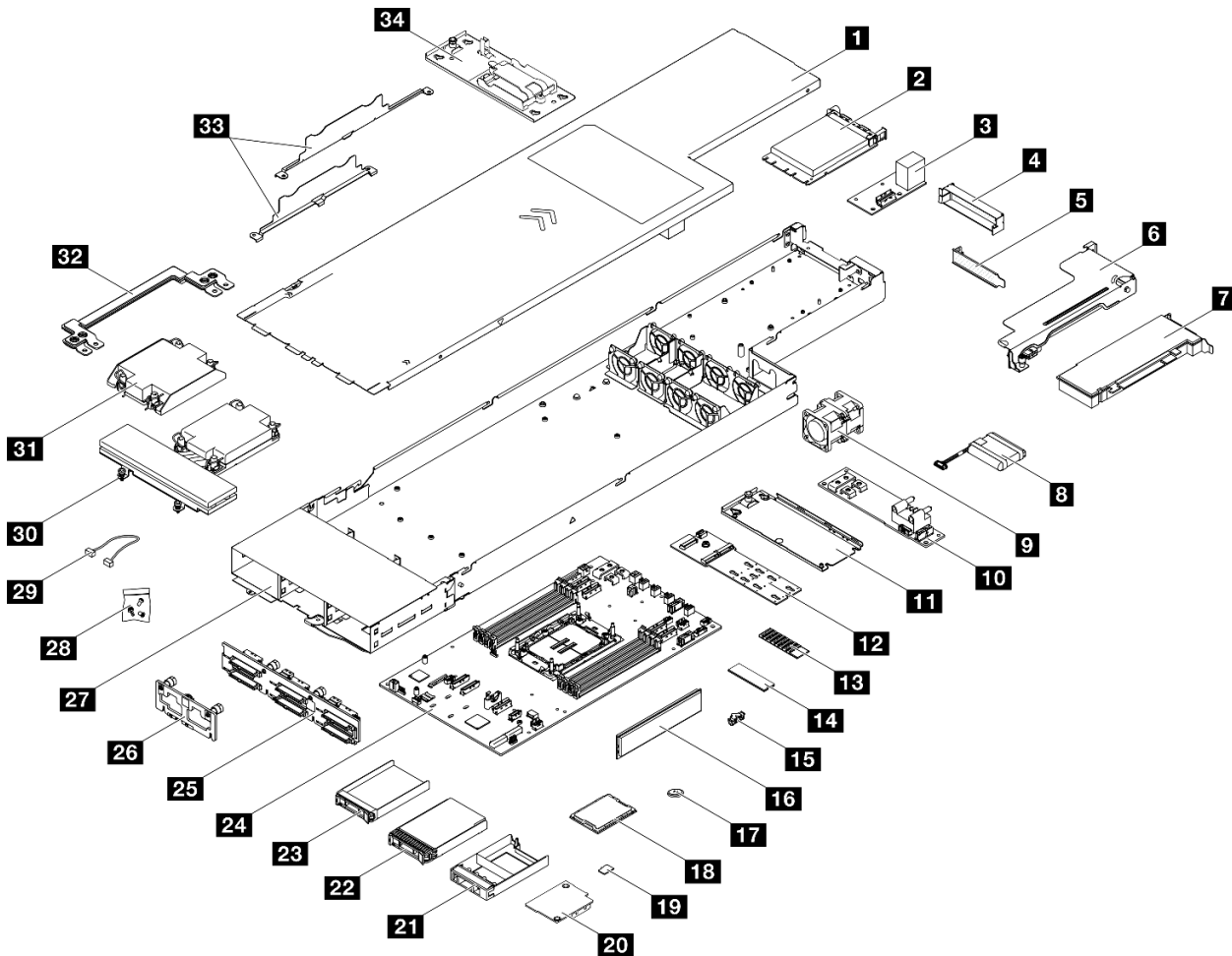

Figure 14. Node components

Description	Type	Description	Type
1 Top cover	T1	2 OCP 3.0 module	T1
3 Rear I/O module	T1	4 PCIe riser filler	T1
5 PCIe filler	T1	6 PCIe riser	T2
7 PCIe adapter	T1	8 Flash power module	T1
9 Fan	T1	10 Power distribution board	T2
11 M.2 boot adapter tray	T1	12 M.2 boot adapter	T1
13 M.2 heat sink	T2	14 M.2 drive	T1
15 M.2 drive retainer	T1	16 Memory module	T1
17 CMOS battery (CR2032)	C	18 Processor	F
19 MicroSD card	T1	20 Firmware and RoT security module	F
21 2.5-inch drive filler	T1	22 2.5-inch drive (15 mm)	T1
23 2.5-inch drive (7 mm)	T1	24 System board	F
25 2.5-inch drive backplane	T1	26 Front I/O board	T1
27 Node tray	F	28 Screws	T1
29 Cables	T1	30 Performance heat sink	F
31 Standard heat sink	F	32 Power bus bar	T1
33 Cable walls	T1	34 Flash power module holder	T1

Power cords

Several power cords are available, depending on the country and region where the server is installed.

To view the power cords that are available for the server:

1. Go to:
<http://dcsc.lenovo.com/#/>
2. Click **Preconfigured Model** or **Configure to order**.
3. Enter the machine type and model for your server to display the configurator page.
4. Click **Power** → **Power Cables** to see all line cords.

Notes:

- For your safety, a power cord with a grounded attachment plug is provided to use with this product. To avoid electrical shock, always use the power cord and plug with a properly grounded outlet.
- Power cords for this product that are used in the United States and Canada are listed by Underwriter's Laboratories (UL) and certified by the Canadian Standards Association (CSA).
- For units intended to be operated at 115 volts: Use a UL-listed and CSA-certified cord set consisting of a minimum 18 AWG, Type SVT or SJT, three-conductor cord, a maximum of 15 feet in length and a parallel blade, grounding-type attachment plug rated 15 amperes, 125 volts.
- For units intended to be operated at 230 volts (U.S. use): Use a UL-listed and CSA-certified cord set consisting of a minimum 18 AWG, Type SVT or SJT, three-conductor cord, a maximum of 15 feet in length and a tandem blade, grounding-type attachment plug rated 15 amperes, 250 volts.

- For units intended to be operated at 230 volts (outside the U.S.): Use a cord set with a grounding-type attachment plug. The cord set should have the appropriate safety approvals for the country in which the equipment will be installed.
- Power cords for a specific country or region are usually available only in that country or region.

Chapter 4. Unboxing and setup

Information in this section assists you on unboxing and setting up the system. When unboxing the chassis and node, check if the items in the package are correct, and learn where to find information of system serial number and Lenovo XClarity Controller access.

System package contents

When you receive your system, verify that the shipment contains everything that you expected to receive.

The system package includes the following items:

- Node
- Chassis
- Rail installation kit*. Installation guide is provided in the package.
- Material box, including items such as power cords*, accessory kit, and printed documents.

Notes:

- Some of the items listed are available on select models only.
- Items marked with asterisk(*) are optional.

If any item is missing or damaged, contact your place of purchase. Make sure that you retain your proof of purchase and packing material. They might be required to receive warranty service.

Identify the system and access the Lenovo XClarity Controller

This section contains instruction on how to identify the system and where to find the Lenovo XClarity Controller access information.

Identifying your system

When you contact Lenovo for help, the machine type, model, and serial number information help support technicians to identify your system and provide faster service.

The illustration below shows the location of the ID label which contains the chassis model number, machine type, and serial number of the chassis. You can also add other system information labels to the front of the node in the customer label spaces.

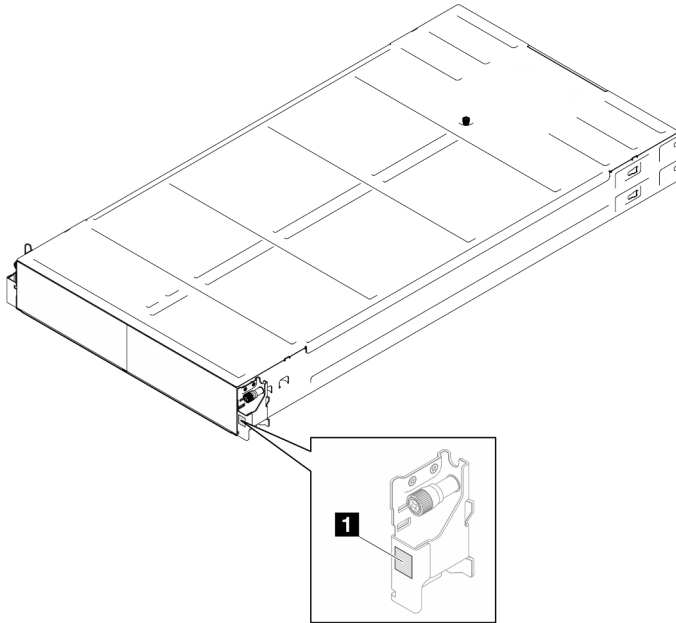

Figure 15. Location of the ID label on the chassis

Table 12. ID label on the front of the chassis

1 ID label

Lenovo XClarity Controller network access label

In addition, the Lenovo XClarity Controller network access label for the node can be found on the pull-out information tag located at the front of the node. This pull-out information tag also shows the bay numbers of the hot-swap drives. You can use the information on the pull-out tag to access the XCC MAC address and LLA for the node. The left node information is at the left bottom side, while the right node information is on the right upper side. You can also use the information tag for your own node labeling information, such as the hostname, the system name, and the inventory bar code.

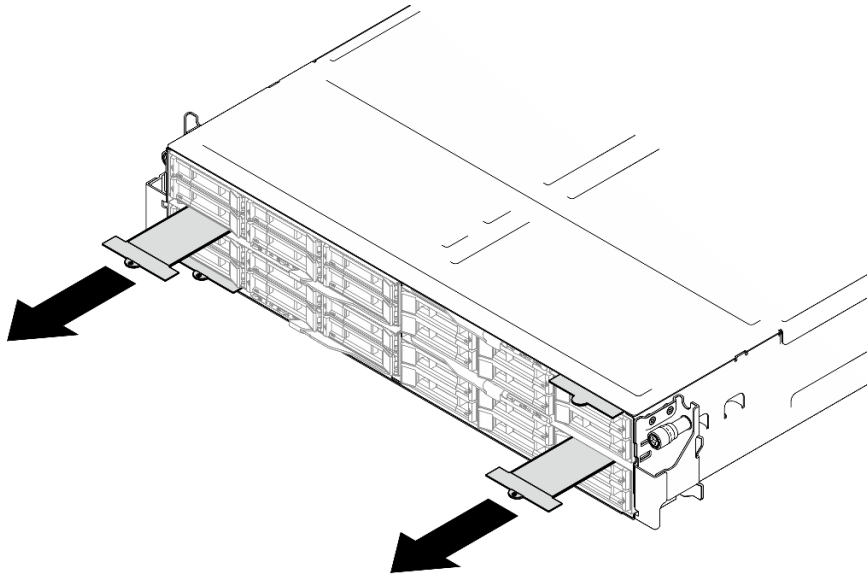

Figure 16. Lenovo XClarity Controller network access label on the pull-out information tab

Service Label and QR code

In addition, the System Service Label is located on the inside surface of the node cover, providing a quick response (QR) code for mobile access to service information. You can scan the QR code with a mobile device using a QR code reader application and get quick access to the Service Information web page. The Service Information web page provides additional information for parts installation and replacement videos, and error codes for system support.

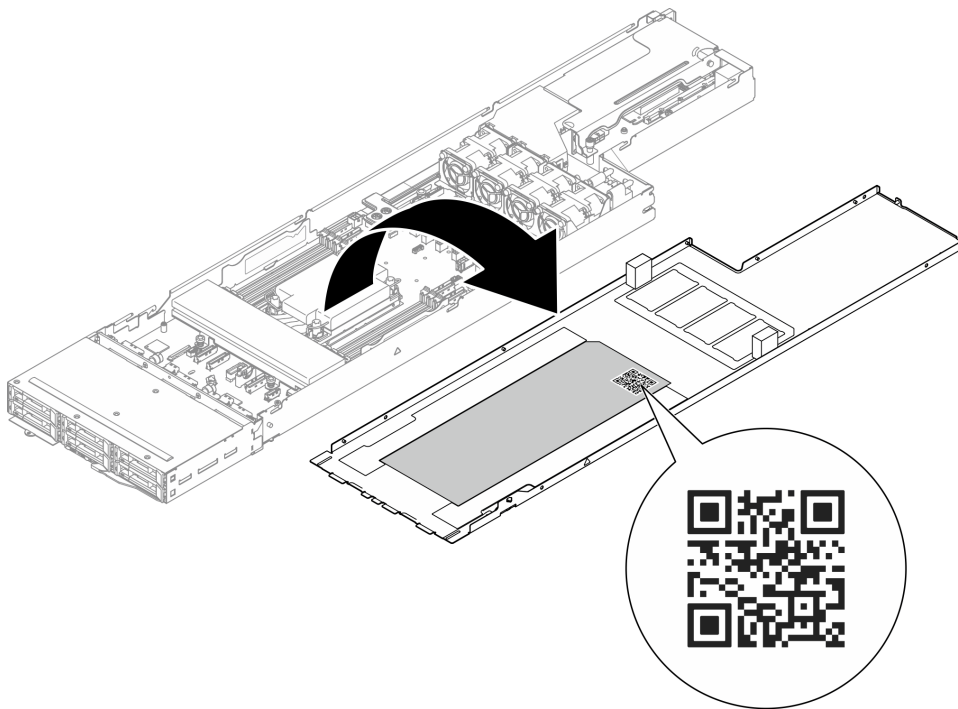

Figure 17. Service Label and QR code

System setup checklist

Use the system setup checklist to make sure that you have performed all tasks that are required to set up your system.

The system setup procedure varies depending on the configuration of the system when it was delivered. In some cases, the system is fully configured and you just need to connect the system to the network and an AC power source, and then you can power on the system. In other cases, the system needs to have hardware options installed, requires hardware and firmware configuration, and requires an operating system to be installed.

The following steps describe the general procedure for setting up a system.

Setup the system hardware

Complete the following procedures to setup the system hardware.

1. Unpack the system package. See [“System package contents” on page 37](#).
2. Install any required hardware or system options. See the related topics in “Hardware replacement procedures” in *User Guide* or *Hardware Maintenance Guide*.
3. If necessary, install the rail to a standard rack cabinet. Follow the instruction in *Rail Installation Guide* that comes with the rail installation kit.
4. To install the chassis to the rack, see “Install the chassis to the rack” in the *User Guide* or *Hardware Maintenance Guide*.

To install the node into the chassis, see “Install a node to the chassis” in the *User Guide* or *Hardware Maintenance Guide*.

5. Connect all external cables to the system. See [Chapter 2 “Hardware components” on page 17](#) for connectors locations.

Typically, you will need to connect the following cables:

- Connect the system to the power source.
 - Connect the system to the data network.
 - Connect the system to the storage device.
 - Connect the system to the management network.
6. Power on the system.

The power button location and power LED are specified in [“Troubleshooting by system LEDs and diagnostics display” on page 26](#).

A node can be turned on (power LED on) in any of the following ways:

- You can press the power button.
- The node can restart automatically after a power interruption.
- The node can respond to remote power-on requests sent to the Lenovo XClarity Controller.

Note: You can access the management processor interface to configure the system without powering on the system. Whenever the system is connected to power, the management processor interface is available. For details about accessing the management system processor, see “Opening and Using the XClarity Controller Web Interface” section in the XCC documentation compatible with your system at <https://pubs.lenovo.com/lxcc-overview/>.

7. Validate the system. Make sure that the power LED, Ethernet connector LED, and network LED are lit with green light, which means the system hardware was set up successfully.

See “[Troubleshooting by system LEDs and diagnostics display](#)” on page 26 for more information on the LED indications.

Configure the system

Complete the following procedures to configure the system. For detailed instructions, refer to [Chapter 5 “System configuration”](#) on page 43.

1. Set the network connection for the Lenovo XClarity Controller to the management network.
2. Update the firmware for the system, if necessary.
3. Configure the firmware for the system.

The following information is available for RAID configuration:

- <https://lenovopress.lenovo.com/lp0578-lenovo-raid-introduction>
 - <https://lenovopress.lenovo.com/lp0579-lenovo-raid-management-tools-and-resources>
4. Install the operating system.
 5. Back up the system configuration.
 6. Install the applications and programs for which the system is intended to be used.

Chapter 5. System configuration

Complete these procedures to configure your system.

Set the network connection for the Lenovo XClarity Controller

Before you can access the Lenovo XClarity Controller over your network, you need to specify how Lenovo XClarity Controller will connect to the network. Depending on how the network connection is implemented, you might need to specify a static IP address as well.

The following methods are available to set the network connection for the Lenovo XClarity Controller if you are not using DHCP:

- If a monitor is attached to the server, you can use Lenovo XClarity Provisioning Manager to set the network connection.

Complete the following steps to connect the Lenovo XClarity Controller to the network using the Lenovo XClarity Provisioning Manager.

1. Start the server.
2. Press the key specified in the on-screen instructions to display the Lenovo XClarity Provisioning Manager interface. (For more information, see the “Startup” section in the LXPM documentation compatible with your server at <https://pubs.lenovo.com/lxpm-overview/>.)
3. Go to **LXPM → UEFI Setup → BMC Settings** to specify how the Lenovo XClarity Controller will connect to the network.
 - If you choose a static IP connection, make sure that you specify an IPv4 or IPv6 address that is available on the network.
 - If you choose a DHCP connection, make sure that the MAC address for the server has been configured in the DHCP server.
4. Click **OK** to apply the setting and wait for two to three minutes.
5. Use an IPv4 or IPv6 address to connect Lenovo XClarity Controller.

Important: The Lenovo XClarity Controller is set initially with a user name of USERID and password of PASSW0RD (with a zero, not the letter O). This default user setting has Supervisor access. It is required to change this user name and password during your initial configuration for enhanced security.

- If no monitor is attached to the server, you can set the network connection through the Lenovo XClarity Controller interface. Connect an Ethernet cable from your laptop to XCC system management port (10/100/1000 Mbps RJ-45) on your server. For the location of the XCC system management port (10/100/1000 Mbps RJ-45), see [Chapter 2 “Hardware components” on page 17](#).

Note: Make sure that you modify the IP settings on the laptop so that it is on the same network as the server default settings.

The default IPv4 address and the IPv6 Link Local Address (LLA) is provided on the Lenovo XClarity Controller Network Access label that is affixed to the Pull Out Information Tab. See [“Identify the system and access the Lenovo XClarity Controller” on page 37](#).

- If you are using the Lenovo XClarity Administrator Mobile app from a mobile device, you can connect to the Lenovo XClarity Controller through the Lenovo XClarity Controller USB connector on the server. For the location of the Lenovo XClarity Controller USB connector, see [Chapter 2 “Hardware components” on page 17](#).

Note: The Lenovo XClarity Controller USB connector mode must be set to manage the Lenovo XClarity Controller (instead of normal USB mode). To switch from normal mode to Lenovo XClarity Controller management mode, hold the ID button on the server for at least 3 seconds until its LED flashes slowly (once every couple of seconds). See [Chapter 2 “Hardware components” on page 17](#) for the location of the ID button.

To connect using the Lenovo XClarity Administrator Mobile app:

1. Connect the USB cable of your mobile device to the Lenovo XClarity Controller USB connector on the server.
2. On your mobile device, enable USB tethering.
3. On your mobile device, launch the Lenovo XClarity Administrator mobile app.
4. If automatic discovery is disabled, click **Discovery** on the USB Discovery page to connect to the Lenovo XClarity Controller.

For more information about using the Lenovo XClarity Administrator Mobile app, see:

https://pubs.lenovo.com/lxca/lxca_usemobileapp

Update the firmware

Several options are available to update the firmware for the system.

The tools listed here can be used to update the most current firmware for the chassis, nodes, and the devices that are installed in the system.

- Best practices related to updating firmware is available at the following site:
 - <https://lenovopress.lenovo.com/lp0656-lenovo-thinksystem-firmware-and-driver-update-best-practices>
- The latest firmware can be found at the following site:
 - <https://datacentersupport.lenovo.com/products/servers/thinksystem/sd520v4/7dfy/downloads/driver-list>
- You can subscribe to product notification to stay up to date on firmware updates:
 - <https://datacentersupport.lenovo.com/solutions/ht509500>

Update Bundles (Service Packs)

Lenovo typically releases firmware in bundles called Update Bundles (Service Packs). To ensure that all of the firmware updates are compatible, you should update all firmware at the same time. If you are updating firmware for both the Lenovo XClarity Controller and UEFI, update the firmware for Lenovo XClarity Controller first.

Update method terminology

- **In-band update.** The installation or update is performed using a tool or application within an operating system that is executing on the server’s core CPU.
- **Out-of-band update.** The installation or update is performed by the Lenovo XClarity Controller collecting the update and then directing the update to the target subsystem or device. Out-of-band updates have no dependency on an operating system executing on the core CPU. However, most out-of-band operations do require the server to be in the S0 (Working) power state.
- **On-Target update.** The installation or update is initiated from an installed operating system executing on the target server itself.
- **Off-Target update.** The installation or update is initiated from a computing device interacting directly with the server’s Lenovo XClarity Controller.

- **Update Bundles (Service Packs).** Update Bundles (Service Packs) are bundled updates designed and tested to provide the interdependent level of functionality, performance, and compatibility. Update Bundles (Service Packs) are server machine-type specific and are built (with firmware and device driver updates) to support specific Windows Server, Red Hat Enterprise Linux (RHEL) and SUSE Linux Enterprise Server (SLES) operating system distributions. Machine-type-specific firmware-only Update Bundles (Service Packs) are also available.

Firmware updating tools

See the following table to determine the best Lenovo tool to use for installing and setting up the firmware:

Tool	Update Methods Supported	Core System Firmware Updates	I/O Devices Firmware Updates	Drive Firmware Updates	Graphical user interface	Command line interface	Supports Static Bundles (Service Packs)	Chassis Mid-plane PSoC Firmware Update
Lenovo XClarity Provisioning Manager (LXPM)	In-band ² On-Target	√			√			
Lenovo XClarity Controller (XCC)	In-band ⁴ Out-of-band Off-Target	√	Selected I/O devices	√ ³	√		√	√
Lenovo XClarity Essentials OneCLI (OneCLI)	In-band Out-of-band On-Target Off-Target	√	All I/O devices	√ ³		√	√	√
Lenovo XClarity Essentials UpdateXpress (LXCE)	In-band Out-of-band On-Target Off-Target	√	All I/O devices		√		√	
Lenovo XClarity Essentials Bootable Media Creator (BoMC)	In-band Out-of-band Off-Target	√	All I/O devices		√ (BoMC application)	√ (BoMC application)	√	

Tool	Update Methods Supported	Core System Firmware Updates	I/O Devices Firmware Updates	Drive Firmware Updates	Graphical user interface	Command line interface	Supports Static Bundles (Service Packs)	Chassis Mid-plane PSoC Firmware Update
Lenovo XClarity Administrator (LXCA)	In-band ¹ Out-of-band ² Off-Target	√	All I/O devices	√	√		√	
Lenovo XClarity Integrator (LXCI) for VMware vCenter	Out-of-band Off-Target	√	Selected I/O devices		√			
Lenovo XClarity Integrator (LXCI) for Microsoft Windows Admin Center	In-band Out-of-band On-Target Off-Target	√	All I/O devices		√		√	

Notes:

1. For I/O firmware updates.
2. For BMC and UEFI firmware updates.
3. Drive firmware update is only supported by the tools and methods below:
 - XCC Bare Metal Update (BMU): In-band, and requires system reboot.
 - Lenovo XClarity Essentials OneCLI: In-band, and does not require system reboot.
4. Bare Metal Update (BMU) only.

• **Lenovo XClarity Provisioning Manager**

From Lenovo XClarity Provisioning Manager, you can update the Lenovo XClarity Controller firmware, the UEFI firmware, and the Lenovo XClarity Provisioning Manager software.

Note: By default, the Lenovo XClarity Provisioning Manager Graphical User Interface is displayed when you start the server and press the key specified in the on-screen instructions. If you have changed that default to be the text-based system setup, you can bring up the Graphical User Interface from the text-based system setup interface.

For additional information about using Lenovo XClarity Provisioning Manager to update firmware, see:

“Firmware Update” section in the LXPM documentation compatible with your server at <https://pubs.lenovo.com/lxpm-overview/>

• **Lenovo XClarity Controller**

If you need to install a specific update, you can use the Lenovo XClarity Controller interface for a specific server.

Notes:

- To perform an in-band update through Windows or Linux, the operating system driver must be installed and the Ethernet-over-USB (sometimes called LAN over USB) interface must be enabled.

For additional information about configuring Ethernet over USB, see:

“Configuring Ethernet over USB” section in the XCC documentation version compatible with your server at <https://pubs.lenovo.com/lxcc-overview/>

- If you update firmware through the Lenovo XClarity Controller, make sure that you have downloaded and installed the latest device drivers for the operating system that is running on the server.

For additional information about using Lenovo XClarity Controller to update firmware, see:

“Updating Server Firmware” section in the XCC documentation compatible with your server at <https://pubs.lenovo.com/lxcc-overview/>

- **Lenovo XClarity Essentials OneCLI**

Lenovo XClarity Essentials OneCLI is a collection of command line applications that can be used to manage Lenovo servers. Its update application can be used to update firmware and device drivers for your servers. The update can be performed within the host operating system of the server (in-band) or remotely through the BMC of the server (out-of-band).

For additional information about using Lenovo XClarity Essentials OneCLI to update firmware, see:

https://pubs.lenovo.com/lxce-onecli/onecli_c_update

- **Lenovo XClarity Essentials UpdateXpress**

Lenovo XClarity Essentials UpdateXpress provides most of OneCLI update functions through a graphical user interface (GUI). It can be used to acquire and deploy Static Bundle update packages and individual updates. Static Bundle contain firmware and device driver updates for Microsoft Windows and for Linux.

You can obtain Lenovo XClarity Essentials UpdateXpress from the following location:

<https://datacentersupport.lenovo.com/solutions/Invo-xpress>

- **Lenovo XClarity Essentials Bootable Media Creator**

You can use Lenovo XClarity Essentials Bootable Media Creator to create bootable media that is suitable for firmware updates, VPD updates, inventory and FFDC collection, advanced system configuration, FoD Keys management, secure erase, RAID configuration, and diagnostics on supported servers.

You can obtain Lenovo XClarity Essentials BoMC from the following location:

<https://datacentersupport.lenovo.com/solutions/Invo-bomc>

- **Lenovo XClarity Administrator**

If you are managing multiple servers using the Lenovo XClarity Administrator, you can update firmware for all managed servers through that interface. Firmware management is simplified by assigning firmware-compliance policies to managed endpoints. When you create and assign a compliance policy to managed endpoints, Lenovo XClarity Administrator monitors changes to the inventory for those endpoints and flags any endpoints that are out of compliance.

For additional information about using Lenovo XClarity Administrator to update firmware, see:

https://pubs.lenovo.com/lxca/update_fw

- **Lenovo XClarity Integrator offerings**

Lenovo XClarity Integrator offerings can integrate management features of Lenovo XClarity Administrator and your server with software used in a certain deployment infrastructure, such as VMware vCenter, Microsoft Admin Center, or Microsoft System Center.

For additional information about using Lenovo XClarity Integrator to update firmware, see:

<https://pubs.lenovo.com/lxci-overview/>

Configure the firmware

Several options are available to install and set up the firmware for the server.

Note: **UEFI Legacy Mode** is not supported by ThinkSystem V4 products.

- **Lenovo XClarity Provisioning Manager (LXPM)**

From Lenovo XClarity Provisioning Manager, you can configure the UEFI settings for your server.

Notes: The Lenovo XClarity Provisioning Manager provides a Graphical User Interface to configure a server. The text-based interface to system configuration (the Setup Utility) is also available. From Lenovo XClarity Provisioning Manager, you can choose to restart the server and access the text-based interface. In addition, you can choose to make the text-based interface the default interface that is displayed when you start LXPM. To do this, go to **Lenovo XClarity Provisioning Manager → UEFI Setup → System Settings → <F1>Start Control → Text Setup**. To start the server with Graphic User Interface, select **Auto** or **Tool Suite**.

See the following documentations for more information:

- Search for the LXPM documentation version compatible with your server at <https://pubs.lenovo.com/lxpm-overview/>
- *UEFI User Guide* at <https://pubs.lenovo.com/uefi-overview/>

- **Lenovo XClarity Essentials OneCLI**

You can use the config application and commands to view the current system configuration settings and make changes to Lenovo XClarity Controller and UEFI. The saved configuration information can be used to replicate or restore other systems.

For information about configuring the server using Lenovo XClarity Essentials OneCLI, see:

https://pubs.lenovo.com/lxce-onecli/onecli_c_settings_info_commands

- **Lenovo XClarity Administrator**

You can quickly provision and pre-provision all of your servers using a consistent configuration. Configuration settings (such as local storage, I/O adapters, boot settings, firmware, ports, and Lenovo XClarity Controller and UEFI settings) are saved as a server pattern that can be applied to one or more managed servers. When the server patterns are updated, the changes are automatically deployed to the applied servers.

Specific details about configuring the server using Lenovo XClarity Administrator are available at:

https://pubs.lenovo.com/lxca/server_configuring

- **Lenovo XClarity Controller**

You can configure the management processor for the server through the Lenovo XClarity Controller Web interface, the command-line interface, or Redfish API.

For information about configuring the server using Lenovo XClarity Controller, see:

“Configuring the Server” section in the XCC documentation compatible with your server at <https://pubs.lenovo.com/lxcc-overview/>

Memory module configuration

Memory performance depends on several variables, such as memory mode, memory speed, memory ranks, memory population and processor.

Information about optimizing memory performance and configuring memory is available at the Lenovo Press website:

<https://lenovopress.lenovo.com/servers/options/memory>

In addition, you can take advantage of a memory configurator, which is available at the following site:

https://dcsc.lenovo.com/#/memory_configuration

Enable Software Guard Extensions (SGX)

Intel® Software Guard Extensions (Intel® SGX) operates under the assumption that the security perimeter includes only the internals of the CPU package, and leaves the DRAM untrusted.

Complete the following steps to enable SGX.

- Step 1. **Make sure** to refer to “Memory module installation rules and order” section in the *User Guide* or *Hardware Maintenance Guide*, which specifies whether your sever supports SGX and lists the memory module population sequence for SGX configuration. (DIMM configuration must be at least 8 DIMMs per socket to support SGX.)
- Step 2. Restart the system. Before the operating system starts up, press the key specified in the on-screen instructions to enter the Setup Utility. (For more information, see the “Startup” section in the LXPM documentation compatible with your server at <https://pubs.lenovo.com/lxpm-overview/>.)
- Step 3. Go to **System settings** → **Processors** → **UMA-Based Clustering** and disable the option.
- Step 4. Go to **System settings** → **Processors** → **Total Memory Encryption (TME)** and enable the option.
- Step 5. Save the changes, then go to **System settings** → **Processors** → **SW Guard Extension (SGX)** and enable the option.

RAID configuration

Using a Redundant Array of Independent Disks (RAID) to store data remains one of the most common and cost-efficient methods to increase server's storage performance, availability, and capacity.

RAID increases performance by allowing multiple drives to process I/O requests simultaneously. RAID can also prevent data loss in case of a drive failure by reconstructing (or rebuilding) the missing data from the failed drive using the data from the remaining drives.

RAID array (also known as RAID drive group) is a group of multiple physical drives that uses a certain common method to distribute data across the drives. A virtual drive (also known as virtual disk or logical drive) is a partition in the drive group that is made up of contiguous data segments on the drives. Virtual drive is presented up to the host operating system as a physical disk that can be partitioned to create OS logical drives or volumes.

An introduction to RAID is available at the following Lenovo Press website:

<https://lenovopress.lenovo.com/lp0578-lenovo-raid-introduction>

Detailed information about RAID management tools and resources is available at the following Lenovo Press website:

<https://lenovopress.lenovo.com/lp0579-lenovo-raid-management-tools-and-resources>

Intel VROC

Enabling Intel VROC

Before setting up RAID for NVMe drives, follow the below steps to enable VROC:

1. Restart the system. Before the operating system starts up, press the key specified in the on-screen instructions to enter the Setup Utility. (For more information, see the “Startup” section in the LXPM documentation compatible with your server at <https://pubs.lenovo.com/lxpm-overview/>.)
2. Go to **System settings** → **Devices and I/O Ports** → **Intel® VMD technology** → **Enable/Disable Intel® VMD** and enable the option.
3. Save the changes and reboot the system.

Intel VROC configurations

Intel offers various VROC configurations with different RAID level and SSD support. See the following for more details.

Notes:

- Supported RAID levels varies by model. For the RAID level supported by , see [Node technical specifications](#).
- For more information about acquiring and installing the activation key, see <https://fod.lenovo.com/lkms>.

Intel VROC configurations for PCIe NVMe SSDs	Requirements
Intel VROC Standard	<ul style="list-style-type: none">• Supports RAID levels 0, 1, and 10• Requires an activation key
Intel VROC Premium	<ul style="list-style-type: none">• Supports RAID levels 0, 1, 5, and 10• Requires an activation key
Bootable RAID	<ul style="list-style-type: none">• RAID 1 only• Supported by 5th Gen Intel® Xeon® Scalable processors (formerly codenamed as Emerald Rapids, EMR)• Requires an activation key
Intel VROC configurations for SATA SSDs	Requirements
Intel VROC SATA RAID	<ul style="list-style-type: none">• Supports RAID levels 0, 1, 5, and 10.

Deploy the operating system

Several options are available to deploy an operating system on the server.

Available operating systems

- Microsoft Windows Server
- VMware ESXi
- Red Hat Enterprise Linux
- SUSE Linux Enterprise Server

Complete list of available operating systems: <https://lenovopress.lenovo.com/osig>.

Tool-based deployment

- **Multi-server**

Available tools:

- Lenovo XClarity Administrator
https://pubs.lenovo.com/lxca/compute_node_image_deployment
- Lenovo XClarity Essentials OneCLI
https://pubs.lenovo.com/lxce-onecli/onecli_r_uxspi_proxy_tool

- **Single-server**

Available tools:

- Lenovo XClarity Provisioning Manager
“OS Installation” section in the LXPM documentation compatible with your server at <https://pubs.lenovo.com/lxpm-overview/>
- Lenovo XClarity Essentials OneCLI
https://pubs.lenovo.com/lxce-onecli/onecli_r_uxspi_proxy_tool

Manual deployment

If you cannot access the above tools, follow the instructions below, download the corresponding *OS Installation Guide*, and deploy the operating system manually by referring to the guide.

1. Go to <https://datacentersupport.lenovo.com/solutions/server-os>.
2. Select an operating system from the navigation pane and click **Resources**.
3. Locate the “OS Install Guides” area and click the installation instructions. Then, follow the instructions to complete the operation system deployment task.

Back up the server configuration

After setting up the server or making changes to the configuration, it is a good practice to make a complete backup of the server configuration.

Make sure that you create backups for the following server components:

- **Management processor**

You can back up the management processor configuration through the Lenovo XClarity Controller interface. For details about backing up the management processor configuration, see:

“Backing up the BMC configuration” section in the XCC documentation compatible with your server at <https://pubs.lenovo.com/lxcc-overview/>.

Alternatively, you can use the `save` command from Lenovo XClarity Essentials OneCLI to create a backup of all configuration settings. For more information about the `save` command, see:

https://pubs.lenovo.com/lxce-onecli/onecli_r_save_command

- **Operating system**

Use your backup methods to back up the operating system and user data for the server.

Appendix A. Getting help and technical assistance

If you need help, service, or technical assistance or just want more information about Lenovo products, you will find a wide variety of sources available from Lenovo to assist you.

On the World Wide Web, up-to-date information about Lenovo systems, optional devices, services, and support are available at:

<http://datacentersupport.lenovo.com>

Note: IBM is Lenovo's preferred service provider for ThinkSystem.

Before you call

Before you call, there are several steps that you can take to try and solve the problem yourself. If you decide that you do need to call for assistance, gather the information that will be needed by the service technician to more quickly resolve your problem.

Attempt to resolve the problem yourself

You can solve many problems without outside assistance by following the troubleshooting procedures that Lenovo provides in the online help or in the Lenovo product documentation. The online help also describes the diagnostic tests that you can perform. The documentation for most systems, operating systems, and programs contains troubleshooting procedures and explanations of error messages and error codes. If you suspect a software problem, see the documentation for the operating system or program.

You can find the product documentation for your ThinkSystem products at the following location:

<https://pubs.lenovo.com/>

You can take these steps to try to solve the problem yourself:

- Check all cables to make sure that they are connected.
- Check the power switches to make sure that the system and any optional devices are turned on.
- Check for updated software, firmware, and operating-system device drivers for your Lenovo product. (See the following links) The Lenovo Warranty terms and conditions state that you, the owner of the Lenovo product, are responsible for maintaining and updating all software and firmware for the product (unless it is covered by an additional maintenance contract). Your service technician will request that you upgrade your software and firmware if the problem has a documented solution within a software upgrade.
 - Drivers and software downloads
 - <https://datacentersupport.lenovo.com/products/servers/thinksystem/sd520v4/7dfy/downloads/driver-list>
 - Operating system support center
 - <https://datacentersupport.lenovo.com/solutions/server-os>
 - Operating system installing instructions
 - <https://pubs.lenovo.com/thinksystem#os-installation>
- If you have installed new hardware or software in your environment, check <https://serverproven.lenovo.com> to make sure that the hardware and software are supported by your product.
- Refer to “Problem Determination” in *User Guide* or *Hardware Maintenance Guide* for instructions on isolating and solving issues.

- Go to <http://datacentersupport.lenovo.com> and check for information to help you solve the problem.

To find the Tech Tips available for your server:

1. Go to <http://datacentersupport.lenovo.com> and navigate to the support page for your server.
2. Click on **How To's** from the navigation pane.
3. Click **Article Type** → **Solution** from the drop-down menu.

Follow the on-screen instructions to choose the category for the problem that you are having.

- Check Lenovo Data Center Forum at https://forums.lenovo.com/t5/Datacenter-Systems/ct-p/sv_eg to see if someone else has encountered a similar problem.

Gathering information needed to call Support

If you require warranty service for your Lenovo product, the service technicians will be able to assist you more efficiently if you prepare the appropriate information before you call. You can also go to <http://datacentersupport.lenovo.com/warrantylookup> for more information about your product warranty.

Gather the following information to provide to the service technician. This data will help the service technician quickly provide a solution to your problem and ensure that you receive the level of service for which you might have contracted.

- Hardware and Software Maintenance agreement contract numbers, if applicable
- Machine type number (Lenovo 4-digit machine identifier). Machine type number can be found on the ID label, see “[Identify the system and access the Lenovo XClarity Controller](#)” on page 37.
- Model number
- Serial number
- Current system UEFI and firmware levels
- Other pertinent information such as error messages and logs

As an alternative to calling Lenovo Support, you can go to <https://support.lenovo.com/servicerequest> to submit an Electronic Service Request. Submitting an Electronic Service Request will start the process of determining a solution to your problem by making the pertinent information available to the service technicians. The Lenovo service technicians can start working on your solution as soon as you have completed and submitted an Electronic Service Request.

Collecting service data

To clearly identify the root cause of a server issue or at the request of Lenovo Support, you might need collect service data that can be used for further analysis. Service data includes information such as event logs and hardware inventory.

Service data can be collected through the following tools:

- **Lenovo XClarity Provisioning Manager**

Use the Collect Service Data function of Lenovo XClarity Provisioning Manager to collect system service data. You can collect existing system log data or run a new diagnostic to collect new data.

- **Lenovo XClarity Controller**

You can use the Lenovo XClarity Controller web interface or the CLI to collect service data for the server. The file can be saved and sent to Lenovo Support.

- For more information about using the web interface to collect service data, see the “Backing up the BMC configuration” section in the XCC documentation compatible with your server at <https://pubs.lenovo.com/lxcc-overview/>.

- For more information about using the CLI to collect service data, see the “XCC `servicelog` command” section in the XCC documentation compatible with your server at <https://pubs.lenovo.com/lxcc-overview/>.

- **Lenovo XClarity Administrator**

Lenovo XClarity Administrator can be set up to collect and send diagnostic files automatically to Lenovo Support when certain serviceable events occur in Lenovo XClarity Administrator and the managed endpoints. You can choose to send diagnostic files to Lenovo Support using Call Home or to another service provider using SFTP. You can also manually collect diagnostic files, open a problem record, and send diagnostic files to the Lenovo Support.

You can find more information about setting up automatic problem notification within the Lenovo XClarity Administrator at https://pubs.lenovo.com/lxca/admin_setupcallhome.

- **Lenovo XClarity Essentials OneCLI**

Lenovo XClarity Essentials OneCLI has inventory application to collect service data. It can run both in-band and out-of-band. When running in-band within the host operating system on the server, OneCLI can collect information about the operating system, such as the operating system event log, in addition to the hardware service data.

To obtain service data, you can run the `getinfor` command. For more information about running the `getinfor`, see https://pubs.lenovo.com/lxce-onecli/onecli_r_getinfor_command.

Contacting Support

You can contact Support to obtain help for your issue.

You can receive hardware service through a Lenovo Authorized Service Provider. To locate a service provider authorized by Lenovo to provide warranty service, go to <https://datacentersupport.lenovo.com/serviceprovider> and use filter searching for different countries. For Lenovo support telephone numbers, see <https://datacentersupport.lenovo.com/supportphonenumberlist> for your region support details.

Appendix B. Documents and supports

This section provides handy documents, driver and firmware downloads, and support resources.

Documents download

This section provides introduction and download link for handy documents.

Documents

Download the following product documentations at:

https://pubs.lenovo.com/sd520-v4/pdf_files

- **Rail Installation Guides**

- Rail installation in a rack

https://pubs.lenovo.com/st650-v2/thinksystem_l_shaped_rail_kit.pdf

- **User Guide**

- Complete overview, system configuration, hardware components replacing, and troubleshooting.

Selected chapters from the *User Guide*:

- **System Configuration Guide** : Server overview, components identification, system LEDs and diagnostics display, product unboxing, setting up and configuring the server.
- **Hardware Maintenance Guide** : Installing hardware components, cable routing, and troubleshooting.

- **Cable Routing Guide**

- Cable routing information.

- **UEFI Manual**

- UEFI setting introduction

Support websites

This section provides driver and firmware downloads and support resources.

Support and downloads

- Lenovo Data Center Forum
 - https://forums.lenovo.com/t5/Datacenter-Systems/ct-p/sv_eg
- Lenovo License Information Documents
 - <https://datacentersupport.lenovo.com/documents/Invo-eula>
- Lenovo Press website (Product Guides/Datasheets/White papers)
 - <https://lenovopress.lenovo.com/>
- Lenovo Privacy Statement
 - <https://www.lenovo.com/privacy>
- Lenovo Product Security Advisories
 - https://datacentersupport.lenovo.com/product_security/home

- Lenovo Product Warranty Plans
 - <http://datacentersupport.lenovo.com/warrantylookup>
- Lenovo Server Operating Systems Support Center website
 - <https://datacentersupport.lenovo.com/solutions/server-os>
- Lenovo ServerProven website (Options compatibility lookup)
 - <https://serverproven.lenovo.com>
- Operating System Installation Instructions
 - <https://pubs.lenovo.com/thinksystem#os-installation>
- Submit an eTicket (service request)
 - <https://support.lenovo.com/servicerequest>
- Subscribe to Lenovo Data Center Group product notifications (Stay up to date on firmware updates)
 - <https://datacentersupport.lenovo.com/solutions/ht509500>

Appendix C. Notices

Lenovo may not offer the products, services, or features discussed in this document in all countries. Consult your local Lenovo representative for information on the products and services currently available in your area.

Any reference to a Lenovo product, program, or service is not intended to state or imply that only that Lenovo product, program, or service may be used. Any functionally equivalent product, program, or service that does not infringe any Lenovo intellectual property right may be used instead. However, it is the user's responsibility to evaluate and verify the operation of any other product, program, or service.

Lenovo may have patents or pending patent applications covering subject matter described in this document. The furnishing of this document is not an offer and does not provide a license under any patents or patent applications. You can send inquiries in writing to the following:

*Lenovo (United States), Inc.
1009 Think Place
Morrisville, NC 27560
U.S.A.
Attention: Lenovo VP of Intellectual Property*

LENOVO PROVIDES THIS PUBLICATION "AS IS" WITHOUT WARRANTY OF ANY KIND, EITHER EXPRESS OR IMPLIED, INCLUDING, BUT NOT LIMITED TO, THE IMPLIED WARRANTIES OF NON-INFRINGEMENT, MERCHANTABILITY OR FITNESS FOR A PARTICULAR PURPOSE. Some jurisdictions do not allow disclaimer of express or implied warranties in certain transactions, therefore, this statement may not apply to you.

This information could include technical inaccuracies or typographical errors. Changes are periodically made to the information herein; these changes will be incorporated in new editions of the publication. Lenovo may make improvements and/or changes in the product(s) and/or the program(s) described in this publication at any time without notice.

The products described in this document are not intended for use in implantation or other life support applications where malfunction may result in injury or death to persons. The information contained in this document does not affect or change Lenovo product specifications or warranties. Nothing in this document shall operate as an express or implied license or indemnity under the intellectual property rights of Lenovo or third parties. All information contained in this document was obtained in specific environments and is presented as an illustration. The result obtained in other operating environments may vary.

Lenovo may use or distribute any of the information you supply in any way it believes appropriate without incurring any obligation to you.

Any references in this publication to non-Lenovo Web sites are provided for convenience only and do not in any manner serve as an endorsement of those Web sites. The materials at those Web sites are not part of the materials for this Lenovo product, and use of those Web sites is at your own risk.

Any performance data contained herein was determined in a controlled environment. Therefore, the result obtained in other operating environments may vary significantly. Some measurements may have been made on development-level systems and there is no guarantee that these measurements will be the same on generally available systems. Furthermore, some measurements may have been estimated through extrapolation. Actual results may vary. Users of this document should verify the applicable data for their specific environment.

Trademarks

Lenovo, the Lenovo logo, ThinkSystem, Flex System, System x, NeXtScale System, and x Architecture are trademarks of Lenovo in the United States, other countries, or both.

Intel and Intel Xeon are trademarks of Intel Corporation in the United States, other countries, or both.

Internet Explorer, Microsoft, and Windows are trademarks of the Microsoft group of companies.

Linux is a registered trademark of Linus Torvalds.

Other company, product, or service names may be trademarks or service marks of others.

Important notes

Processor speed indicates the internal clock speed of the processor; other factors also affect application performance.

CD or DVD drive speed is the variable read rate. Actual speeds vary and are often less than the possible maximum.

When referring to processor storage, real and virtual storage, or channel volume, KB stands for 1 024 bytes, MB stands for 1 048 576 bytes, and GB stands for 1 073 741 824 bytes.

When referring to drive capacity or communications volume, MB stands for 1 000 000 bytes, and GB stands for 1 000 000 000 bytes. Total user-accessible capacity can vary depending on operating environments.

Maximum internal drive capacities assume the replacement of any standard drives and population of all drive bays with the largest currently supported drives that are available from Lenovo.

Maximum memory might require replacement of the standard memory with an optional memory module.

Each solid-state memory cell has an intrinsic, finite number of write cycles that the cell can incur. Therefore, a solid-state device has a maximum number of write cycles that it can be subjected to, expressed as total bytes written (TBW). A device that has exceeded this limit might fail to respond to system-generated commands or might be incapable of being written to. Lenovo is not responsible for replacement of a device that has exceeded its maximum guaranteed number of program/erase cycles, as documented in the Official Published Specifications for the device.

Lenovo makes no representations or warranties with respect to non-Lenovo products. Support (if any) for the non-Lenovo products is provided by the third party, not Lenovo.

Some software might differ from its retail version (if available) and might not include user manuals or all program functionality.

Electronic emission notices

When you attach a monitor to the equipment, you must use the designated monitor cable and any interference suppression devices that are supplied with the monitor.

Taiwan Region BSMI RoHS declaration

單元 Unit	限用物質及其化學符號 Restricted substances and its chemical symbols					
	鉛Lead (Pb)	汞Mercury (Hg)	鎘Cadmium (Cd)	六價鉻 Hexavalent chromium (Cr ⁶⁺)	多溴聯苯 Polybrominated biphenyls (PBB)	多溴二苯醚 Polybrominated diphenyl ethers (PBDE)
機架	○	○	○	○	○	○
外部蓋板	○	○	○	○	○	○
機械組合件	-	○	○	○	○	○
空氣傳動設備	-	○	○	○	○	○
冷卻組合件	-	○	○	○	○	○
內存模組	-	○	○	○	○	○
處理器模組	-	○	○	○	○	○
電纜組合件	-	○	○	○	○	○
儲備設備	-	○	○	○	○	○
印刷電路板	-	○	○	○	○	○

備考1. “超出0.1 wt %” 及 “超出0.01 wt %” 係指限用物質之百分比含量超出百分比含量基準值。
 Note1: “exceeding 0.1wt%” and “exceeding 0.01 wt%” indicate that the percentage content of the restricted substance exceeds the reference percentage value of presence condition.

備考2. “○” 係指該項限用物質之百分比含量未超出百分比含量基準值。
 Note2: “○” indicates that the percentage content of the restricted substance does not exceed the percentage of reference value of presence.

備考3. “-” 係指該項限用物質為排除項目。
 Note3: The “-” indicates that the restricted substance corresponds to the exemption.

Taiwan import and export contact information

Contacts are available for Taiwan import and export information.

委製商/進口商名稱: 台灣聯想環球科技股份有限公司
進口商地址: 台北市南港區三重路 66 號 8 樓
進口商電話: 0800-000-702

Lenovo